

Approval body for construction products
and types of construction

Bautechnisches Prüfamt

An institution established by the Federal and
Laender Governments



European Technical Assessment

ETA-19/0632
of 28 October 2020

English translation prepared by DIBt - Original version in German language

General Part

Technical Assessment Body issuing the
European Technical Assessment:

Deutsches Institut für Bautechnik

Trade name of the construction product

Injection System Hilti HIT-HY 200-R V3 with HIT-Z /
HIT-Z-F / HIT-Z-R

Product family
to which the construction product belongs

Bonded expansion fastener for use in concrete

Manufacturer

Hilti Aktiengesellschaft
Feldkircherstrasse 100
9494 SCHAAN
FÜRSTENTUM LIECHTENSTEIN

Manufacturing plant

Hilti Werke
Hilti Plants

This European Technical Assessment
contains

20 pages including 3 annexes which form an integral part
of this assessment

This European Technical Assessment is
issued in accordance with Regulation (EU)
No 305/2011, on the basis of

EAD 330499-01-0601 Edition 04/2020

This version replaces

ETA-19/0632 issued on 6 April 2020

The European Technical Assessment is issued by the Technical Assessment Body in its official language. Translations of this European Technical Assessment in other languages shall fully correspond to the original issued document and shall be identified as such.

Communication of this European Technical Assessment, including transmission by electronic means, shall be in full. However, partial reproduction may only be made with the written consent of the issuing Technical Assessment Body. Any partial reproduction shall be identified as such.

This European Technical Assessment may be withdrawn by the issuing Technical Assessment Body, in particular pursuant to information by the Commission in accordance with Article 25(3) of Regulation (EU) No 305/2011.

Specific Part

1 Technical description of the product

The injection system Hilti HIT-HY 200-R V3 with HIT-Z / HIT-Z-F / HIT-Z-R is a bonded expansion fastener consisting of a foil pack with injection mortar Hilti HIT-HY 200-R V3 and an anchor rod (including nut and washer) according to Annex A2. The anchor rod is placed into a drill hole filled with injection mortar. The load transfer is realised by mechanical interlock of several cones in the bonding mortar and then via a combination of bonding and friction forces in the base material (concrete).

The product description is given in Annex A.

2 Specification of the intended use in accordance with the applicable European Assessment Document

The performances given in Section 3 are only valid if the anchor is used in compliance with the specifications and conditions given in Annex B.

The verifications and assessment methods on which this European Technical Assessment is based lead to the assumption of a working life of the anchor of at least 50 and/or 100 years. The indications given on the working life cannot be interpreted as a guarantee given by the producer, but are to be regarded only as a means for choosing the right products in relation to the expected economically reasonable working life of the works.

3 Performance of the product and references to the methods used for its assessment

3.1 Mechanical resistance and stability (BWR 1)

Essential characteristic	Performance
Characteristic resistance to tension load (static and quasi-static loading)	See Annex C1, B2 – B3
Characteristic resistance to shear load (static and quasi-static loading)	See Annex C2
Displacements under short-term and long-term loading	See Annex C3
Characteristic resistance and displacements for seismic performance categories C1 and C2	See Annex C4 – C6

3.2 Hygiene, health and the environment (BWR 3)

Essential characteristic	Performance
Content, emission and/or release of dangerous substances	No performance assessed

4 Assessment and verification of constancy of performance (AVCP) system applied, with reference to its legal base

In accordance with EAD 330499-01-0601 the applicable European legal act is: [96/582/EC]
 The system to be applied is: 1

5 Technical details necessary for the implementation of the AVCP system, as provided for in the applicable European Assessment Document

Technical details necessary for the implementation of the AVCP system are laid down in the control plan deposited at Deutsches Institut für Bautechnik.

Issued in Berlin on 28 October 2020 by Deutsches Institut für Bautechnik

Dipl.-Ing. Beatrix Wittstock
Head of Section

beglaubigt:
Lange

Installed condition

Figure A1:

HIT-Z, HIT-Z-F, HIT-Z-R

Pre-setting:

Install fastener before positioning fixture

Through-setting:

Install fastener through positioned fixture

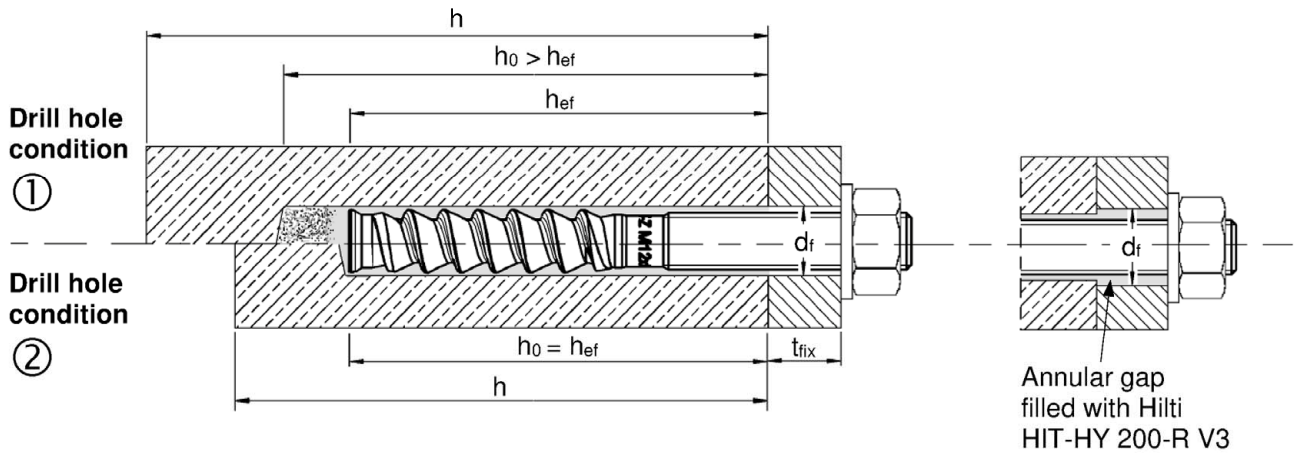

Drill hole condition ① → non-cleaned drill hole

Drill hole condition ② → drilling dust is removed

Injection system Hilti HIT-HY 200-R V3 with HIT-Z / HIT-Z-F / HIT-Z-R

Product description
Installed condition

Annex A1

Product description: Injection mortar and steel elements

Injection mortar Hilti HIT-HY 200-R V3: hybrid system with aggregate
330 ml and 500 ml

Marking:
HILTI HIT
HY 200-R V3
Production number and
production line
Expiry date mm/yyyy



Product name: "Hilti HIT-HY 200-R V3"

Static mixer Hilti HIT-RE-M



Steel elements

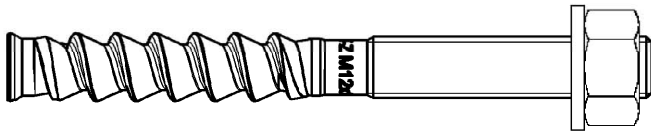

Hilti fastner: HIT-Z and HIT-Z-R: M8 to M20
Hilti fastener: HIT-Z-F: M16 and M20

Hilti Filling Set to fill the annular gap between fastener and fixture

Filling washer

Spherical washer

Lock nut

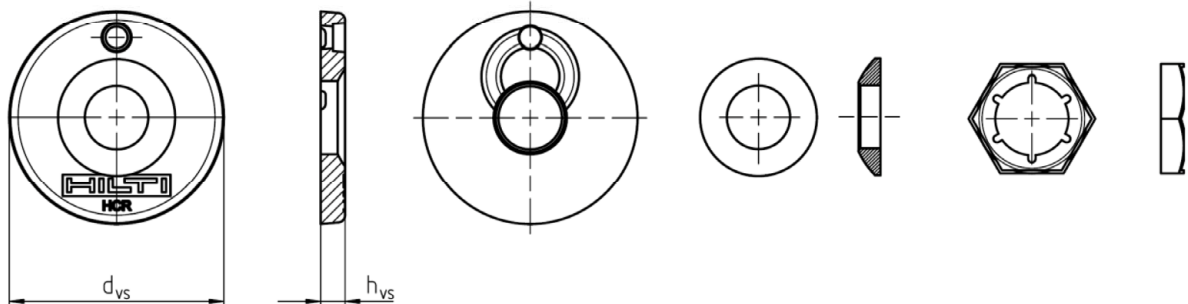

Table A1: Geometry of Hilti filling set

Hilti Filling Set		M16	M20
Diameter of filling washer	d_{vs} [mm]	52	60
Thickness of filling washer	h_{vs} [mm]	6	
Thickness of Hilti Filling Set	h_{fs} [mm]	11	13

Injection system Hilti HIT-HY 200-R V3 with HIT-Z / HIT-Z-F / HIT-Z-R

Product description
Injection mortar / Static mixer / Steel elements / Filling set

Annex A2

Table A2: Materials

Designation	Material
Metal parts made of zinc coated steel	
Fastener HIT-Z	For \leq M12: $f_{uk} = 650$ N/mm ² , $f_{yk} = 520$ N/mm ² , For M16: $f_{uk} = 610$ N/mm ² , $f_{yk} = 490$ N/mm ² , For M20: $f_{uk} = 595$ N/mm ² , $f_{yk} = 480$ N/mm ² , Elongation at fracture ($l_0=5d$) > 8% ductile Electroplated zinc coated ≥ 5 μ m
Washer	Electroplated zinc coated ≥ 5 μ m
Nut	Strength class of nut adapted to strength class of fastener Electroplated zinc coated ≥ 5 μ m
Hilti Filling Set	Filling washer: Electroplated zinc coated ≥ 5 μ m Spherical washer: Electroplated zinc coated ≥ 5 μ m Lock nut: Electroplated zinc coated ≥ 5 μ m
Metal parts made of multilayer coated steel	
Fastener HIT-Z-F	For M16: $f_{uk} = 610$ N/mm ² , $f_{yk} = 490$ N/mm ² , For M20: $f_{uk} = 595$ N/mm ² , $f_{yk} = 480$ N/mm ² , Elongation at fracture ($l_0=5d$) > 8% ductile; Multilayer coating, ZnNi-galvanized according to DIN 50979:2008-07
Washer	Multilayer coating, ZnNi-galvanized according to DIN 50979:2008-07
Nut	Multilayer coating, ZnNi-galvanized according to DIN 50979:2008-07
Hilti Filling Set	Filling washer: hot dip galvanized ≥ 45 μ m Spherical washer: hot dip galvanized ≥ 45 μ m Lock nut: hot dip galvanized ≥ 45 μ m
Metal parts made of stainless steel corrosion resistance class III according EN 1993-1-4:2006+A1:2015	
Fastener HIT-Z-R	For \leq M12: $f_{uk} = 650$ N/mm ² , $f_{yk} = 520$ N/mm ² , For M16: $f_{uk} = 610$ N/mm ² , $f_{yk} = 490$ N/mm ² , For M20: $f_{uk} = 595$ N/mm ² , $f_{yk} = 480$ N/mm ² , Elongation at fracture ($l_0=5d$) > 8% ductile Stainless steel 1.4401, 1.4404 EN 10088-1:2014
Washer	Stainless steel A4 according to EN 10088-1:2014
Nut	Strength class of nut adapted to strength class of fastener Stainless steel 1.4401, 1.4404 EN 10088-1:2014
Hilti Filling Set	Filling washer: stainless steel A4 according to EN 10088-1:2014 Spherical washer: stainless steel A4 according to EN 10088-1:2014 Lock nut: stainless steel A4 according to EN 10088-1:2014

Injection system Hilti HIT-HY 200-R V3 with HIT-Z / HIT-Z-F / HIT-Z-R

Product description
Materials

Annex A3

Specifications of intended use

Fastenings subject to:

- Static and quasi static loading
 - HIT-Z and HIT-Z-R size M8 to M20. HIT-Z-F sizes M16 and M20
- Seismic performance category:
 - Seismic C1: HIT-Z, HIT-Z-R sizes M8 to M20, HIT-Z-F sizes M16 and M20 in hammer drilled holes.
 - Seismic C2: HIT-Z, HIT-Z-R sizes M12 to M20, HIT-Z-F sizes M16 and M20 in hammer drilled holes.

Base material:

- Compacted reinforced or unreinforced normal weight concrete without fibres according to EN 206:2013+A1:2016.
- Strength classes C20/25 to C50/60 according to EN 206:2013+A1:2016.
- Cracked and uncracked concrete.

Temperature in the base material:

- at installation
+5 °C to +40 °C
- in-service
 - Temperature range I: -40 °C to +40 °C
(max. long term temperature +24 °C and max. short term temperature +40 °C)
 - Temperature range II: -40 °C to +80 °C
(max. long term temperature +50 °C and max. short term temperature +80 °C)
 - Temperature range III: -40 °C to +120 °C
(max. long term temperature +72 °C and max. short term temperature +120 °C)

Use conditions (Environmental conditions):

- Structures subject to dry internal conditions (all materials).
- For all other conditions according EN 1993-1-4:2006+A1:2015 corresponding to corrosion resistance class Table A2 Annex A3. (stainless steels)

Design:

- Fastenings are designed under the responsibility of an engineer experienced in fastenings and concrete work.
- Verifiable calculation notes and drawings are prepared taking account of the loads to be fastened. The position of the fastener is indicated on the design drawings (e. g. position of the fastener relative to reinforcement or to supports, etc.).
- The fastenings are designed in accordance with EN 1992-4:2018 and EOTA Technical Report TR 055.

Installation:

- Concrete condition I1: Installation in dry or wet (water saturated) concrete and use in service in dry or wet concrete
- Installation direction D3: downward and horizontal and upward (e.g. overhead).
- Drilling technique: hammer drilling, diamond coring or hammer drilling with hollow drill bit TE-CD, TE-YD
- Fastener installation carried out by appropriately qualified personnel and under the supervision of the person responsible for technical matters of the site.

Injection system Hilti HIT-HY 200-R V3 with HIT-Z / HIT-Z-F / HIT-Z-R

Intended Use
Specifications

Annex B1

Table B1: Installation parameters HIT-Z, HIT-Z-F and HIT-Z-R

		M8	M10	M12	M16	M20
Diameter of embedded part	d [mm]	8	10	12	16	20
Nominal drill hole diameter	d ₀ [mm]	10	12	14	18	22
Length of fastener	min l [mm]	80	95	105	155	215
	max l [mm]	120	160	196	420	450
Length of helix	l _{Helix} [mm]	35 or 50	50 or 60	60	96	100
Effective embedment depth	h _{ef,min} [mm]	60	60	60	96	100
	h _{ef,max} [mm]	100	120	144	192	220
Drill hole condition ① Min. thickness of concrete member	h _{min} [mm]	h _{ef} + 60 mm			h _{ef} + 100 mm	
Drill hole condition ② Min. thickness of concrete member	h _{min} [mm]	h _{ef} + 30 mm ≥ 100 mm			h _{ef} + 45 mm	
Maximum depth of drill hole	h ₀ [mm]	h – 30 mm			h – 2 d ₀	
Pre-setting: Maximum diameter of clearance hole in the fixture	d _f [mm]	9	12	14	18	22
Through-setting: Maximum diameter of clearance hole in the fixture	d _f [mm]	11	14	16	20	24
Maximum fixture thickness	t _{fix} [mm]	48	87	120	303	326
Maximum fixture thickness with filling set	t _{fix} [mm]	41	79	111	292	314
Installation torque	HIT-Z, HIT-Z-F T _{inst} [Nm]	10	25	40	80	150
	HIT-Z-R T _{inst} [Nm]	30	55	75	155	215

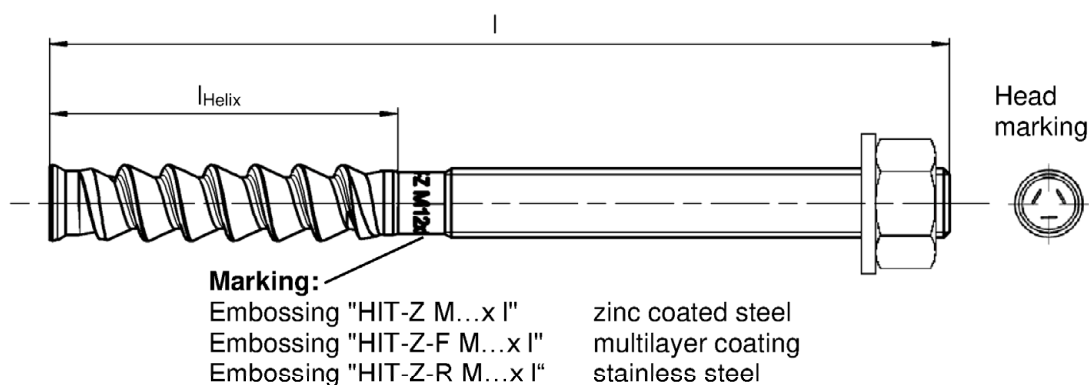

Injection system Hilti HIT-HY 200-R V3 with HIT-Z / HIT-Z-F / HIT-Z-R

Intended Use
Installation parameters

Annex B2

Minimum edge distance and spacing

For the calculation of minimum spacing s_{min} and minimum edge distance c_{min} of fasteners in combination with different embedment depth and thickness of concrete member the following equation shall be fulfilled:

$$A_{i,req} < A_{i,ef}$$

Table B2: Required area $A_{i,req}$

HIT-Z, HIT-Z-F, HIT-Z-R		M8	M10	M12	M16	M20
Cracked concrete	$A_{i,req}$ [mm ²]	19200	40800	58800	94700	148000
Non-cracked concrete	$A_{i,req}$ [mm ²]	22200	57400	80800	128000	198000

Table B3: Effective area $A_{i,ef}$

Member thickness $h > h_{ef} + 1,5 \cdot c$			
Single fastener and group of fasteners with $s > 3 \cdot c$	[mm ²]	$A_{i,ef} = (6 \cdot c) \cdot (h_{ef} + 1,5 \cdot c)$	with $c \geq 5 \cdot d$
Group of fasteners with $s \leq 3 \cdot c$	[mm ²]	$A_{i,ef} = (3 \cdot c + s) \cdot (h_{ef} + 1,5 \cdot c)$	with $c \geq 5 \cdot d$ and $s \geq 5 \cdot d$
Member thickness $h \leq h_{ef} + 1,5 \cdot c$			
Single fastener and group of fasteners with $s > 3 \cdot c$	[mm ²]	$A_{i,ef} = (6 \cdot c) \cdot h$	with $c \geq 5 \cdot d$
Group of fasteners with $s \leq 3 \cdot c$	[mm ²]	$A_{i,ef} = (3 \cdot c + s) \cdot h$	with $c \geq 5 \cdot d$ and $s \geq 5 \cdot d$

c_{min} and s_{min} in 5 mm steps

Injection system Hilti HIT-HY 200-R V3 with HIT-Z / HIT-Z-F / HIT-Z-R

Intended Use

Installation parameters: member thickness, spacing and edge distances





Annex B3

Table B4: Maximum working time and minimum curing time

Temperature in the base material T ¹⁾	Maximum working time t _{work}	Minimum curing time t _{cure}
5 °C	45 min	4 hours
6 °C to 10 °C	30 min	2,5 hours
11 °C to 20 °C	15 min	1,5 hours
21 °C to 30 °C	9 min	1 hours
31 °C to 40 °C	6 min	1 hours

¹⁾ The minimum foil pack temperature is 0 °C

Table B5: Parameters of drilling and setting tools

Fastener	Drill			Installation
	Hammer drilling		Diamond coring	
HIT-Z / HIT-Z(-F,-R)	Drill bit	Hollow drill bit TE-CD, TE-YD		
				
Size	d ₀ [mm]	d ₀ [mm]	d ₀ [mm]	HIT-SZ
M8	10	-	10	-
M10	12	12	12	12
M12	14	14	14	14
M16	18	18	18	18
M20	22	22	22	22

Injection system Hilti HIT-HY 200-R V3 with HIT-Z / HIT-Z-F / HIT-Z-R

Intended Use

Maximum working time and minimum curing time
Cleaning and setting tools

Annex B4

Installation instruction

Hole drilling

a) Hammer drilling

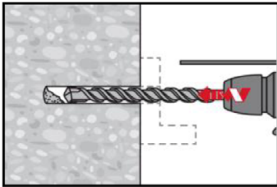

Through-setting: Drill hole through the clearance hole in the fixture to the required drilling depth with a hammer drill set in rotation-hammer mode using an appropriately sized carbide drill bit.

Pre-setting: Drill hole to the required drilling depth with a hammer drill set in rotation-hammer mode using an appropriately sized carbide drill bit.
After drilling is complete, proceed to the "injection preparation" step in the installation instruction.

b) Hammer drilling with Hilti hollow drill bit

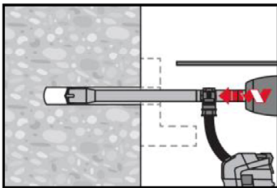

Pre- / Through-setting: Drill hole to the required embedment depth with an appropriately sized Hilti TE-CD or TE-YD hollow drill bit with Hilti vacuum attachment. This drilling system removes the dust and cleans the drill hole during drilling when used in accordance with the user's manual (see Annex A1 – Drill hole condition ②).
After drilling is completed, proceed to the "injection preparation" step in the installation instruction.

c) Diamond coring

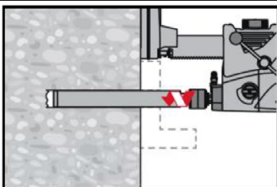

Diamond coring is permissible when suitable diamond core drilling machines and corresponding core bits are used.

Through-setting: Drill hole through the clearance hole in the fixture to the required drilling depth.
Pre-setting: Drill hole to the required embedment depth.

Drill hole cleaning

a) No cleaning required for hammer drilled holes.

b) Hole flushing and evacuation required for wet-drilled diamond cored holes.

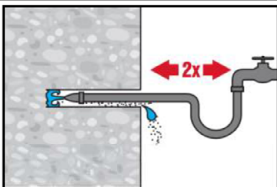

Flush 2 times from the back of the hole over the whole length until water runs clear. Water-line pressure is sufficient.

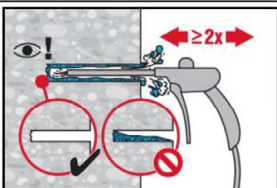

Blow 2 times from the back of the hole (if needed with nozzle extension) with oil-free compressed air (min. 6 bar at 6 m³/h) to evacuate the water.

Injection system Hilti HIT-HY 200-R V3 with HIT-Z / HIT-Z-F / HIT-Z-R

Intended Use
Installation instructions

Annex B5

Checking of setting depth

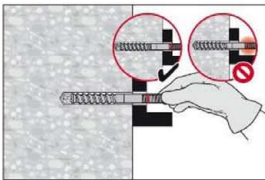
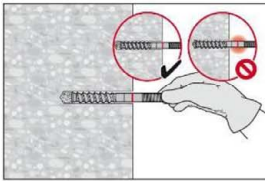

Mark the element and check the setting depth. The element has to fit in the hole until the required embedment depth. If it is not possible to insert the element to the required embedment depth, remove the dust in the drill hole or drill deeper.

Injection preparation

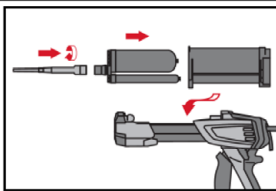

Tightly attach Hilti mixing nozzle HIT-RE-M to foil pack manifold. Do not modify the mixing nozzle.
Observe the instruction for use of the dispenser.
Check foil pack holder for proper function. Insert foil pack into foil pack holder and put holder into the dispenser.

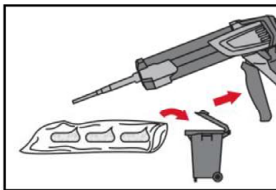

The foil pack opens automatically as dispensing is initiated. Depending on the size of the foil pack an initial amount of adhesive has to be discarded. Discarded quantities are:

2 strokes	for 330 ml foil pack,
3 strokes	for 500 ml foil pack.

Inject adhesive from the back of the drill hole without forming air voids.

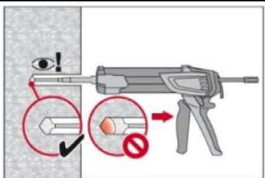

Inject the adhesive starting at the back of the hole, slowly withdrawing the mixer with each trigger pull.

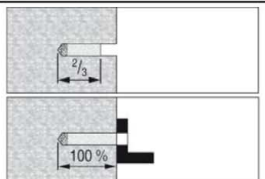

Pre-setting: Fill approximately 2/3 of the drill hole.

Through-setting: Fill 100% of the drill hole

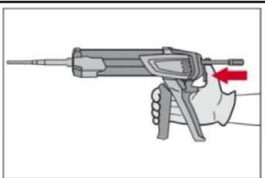

After injection is completed, depressurize the dispenser by pressing the release trigger. This will prevent further adhesive discharge from the mixer.

Injection system Hilti HIT-HY 200-R V3 with HIT-Z / HIT-Z-F / HIT-Z-R

Intended Use
Installation instructions

Annex B6

Overhead installation

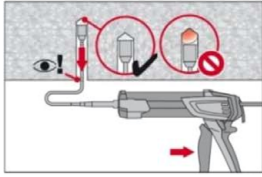

For overhead installation the injection is only possible with the aid of extensions and piston plugs. Assemble HIT-RE-M mixer, extension(s) and appropriately sized piston plug Hilti HIT-SZ (see Table B5). Insert piston plug to back of the hole and inject adhesive. During injection the piston plug will be naturally extruded out of the drill hole by the adhesive pressure.

Setting the element

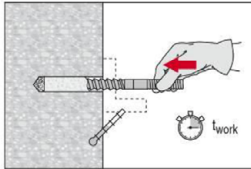

Before use, verify that the element is dry and free of oil and other contaminants. Set element to the required embedment depth before working time t_{work} has elapsed. The working time t_{work} is given in Table B4. After setting the element the annular gap between the fastener and the fixture (through-setting) or concrete (pre-setting) has to be filled with mortar.

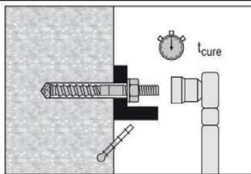

After required curing time t_{cure} (see Table B4) remove excess mortar. The required installation torque T_{inst} is given in Table B1. The fastener can be loaded.

Installation with Hilti filling set

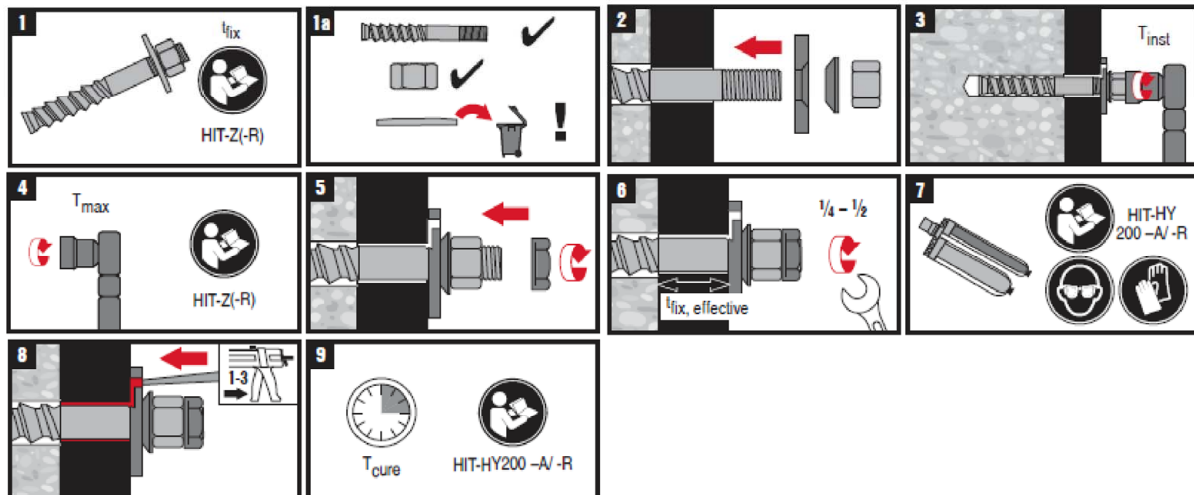

Injection system Hilti HIT-HY 200-R V3 with HIT-Z / HIT-Z-F / HIT-Z-R

Intended Use
Installation instructions

Annex B7

Table C1: Essential characteristics for HIT-Z (-F, -R), under tension load in case of static and quasi static loading

			M8	M10	M12	M16	M20
Installation factor	γ_{inst}	[-]	1,0				
Steel failure							
HIT-Z, HIT-Z-F	$N_{Rk,s}$	[kN]	24	38	55	96	146
HIT-Z-R	$N_{Rk,s}$	[kN]	24	38	55	96	146
Pull-out failure							
in uncracked concrete							
Temperature range I:	40 °C / 24 °C	$\frac{N_{Rk,p,ucr}}{N_{Rk,p,ucr,100}}$ [kN]	26	44	50	115	150
Temperature range II:	80 °C / 50 °C	$\frac{N_{Rk,p,ucr}}{N_{Rk,p,ucr,100}}$ [kN]	24	40	48	105	135
Temperature range III:	120 °C / 72 °C	$\frac{N_{Rk,p,ucr}}{N_{Rk,p,ucr,100}}$ [kN]	22	36	44	95	125
in cracked concrete							
Temperature range I:	40 °C / 24 °C	$\frac{N_{Rk,p,cr}}{N_{Rk,p,cr,100}}$ [kN]	22	40	48	105	135
Temperature range II:	80 °C / 50 °C	$\frac{N_{Rk,p,cr}}{N_{Rk,p,cr,100}}$ [kN]	20	36	44	95	125
Temperature range III:	120 °C / 72 °C	$\frac{N_{Rk,p,cr}}{N_{Rk,p,cr,100}}$ [kN]	18	32	40	85	110
Concrete cone failure							
Effective embedment depth	$h_{ef,min}$	[mm]	60	60	60	96	100
	$h_{ef,max}$	[mm]	100	120	144	192	220
Factor for uncracked concrete	$k_{ucr,N}$	[-]	11,0				
Factor for cracked concrete	$k_{cr,N}$	[-]	7,7				
Edge distance	$c_{cr,N}$	[mm]	$1,5 \cdot h_{ef}$				
Spacing	$s_{cr,N}$	[mm]	$3,0 \cdot h_{ef}$				
Splitting failure							
Edge distance $c_{cr,sp}$ [mm] for	$h / h_{ef} \geq 2,35$		$1,5 \cdot h_{ef}$				
	$2,35 > h / h_{ef} > 1,35$		$6,2 \cdot h_{ef} - 2,0 \cdot h$				
	$h / h_{ef} \leq 1,35$		$3,5 \cdot h_{ef}$				
Spacing	$s_{cr,sp}$	[mm]	$2 \cdot c_{cr,sp}$				

Injection system Hilti HIT-HY 200-R V3 with HIT-Z / HIT-Z-F / HIT-Z-R

Performances

Essential characteristics under tension load in case of static and quasi static loading

Annex C1

Table C2: Essential characteristics for HIT-Z (-F, -R) under shear load for static and quasi static loading

			M8	M10	M12	M16	M20
Installation factor	γ_{inst}	[-]	1,0				
Steel failure without lever arm							
HIT-Z, HIT-Z-F	$V_{RK,s}^0$	[kN]	12	19	27	48	73
HIT-Z-R	$V_{RK,s}^0$	[kN]	14	23	33	57	88
Ductility factor	k_7	[-]	1,0				
Steel failure with lever arm							
HIT-Z, HIT-Z-F	$M_{RK,s}^0$	[Nm]	24	49	85	203	386
HIT-Z-R	$M_{RK,s}^0$	[Nm]	24	49	85	203	386
Ductility factor	k_7	[-]	1,0				
Concrete pry-out failure							
Pry-out factor	k_8	[-]	2,47	2,47	2,92	2,56	2,56
Concrete edge failure							
Effective length of fastener	l_f	[mm]	h_{ef}				
Effective diameter of fastener	d_{nom}	[mm]	8	10	12	16	20

Injection system Hilti HIT-HY 200-R V3 with HIT-Z / HIT-Z-F / HIT-Z-R

Performances

Essential characteristics under shear load in case of static and quasi static loading

Annex C2

Table C3: Displacements under tension load for HIT-Z (-F, -R) for static and quasi static loading¹⁾

		M8	M10	M12	M16	M20
Uncracked concrete, Temperature range I: 40 °C / 24 °C						
Displacement	δ_{N0} [mm/kN]	0,03	0,03	0,04	0,05	0,07
	$\delta_{N\infty}$ [mm/kN]	0,06	0,08	0,10	0,13	0,17
Uncracked concrete, Temperature range II: 80 °C / 50 °C						
Displacement	δ_{N0} [mm/kN]	0,03	0,04	0,04	0,06	0,07
	$\delta_{N\infty}$ [mm/kN]	0,07	0,09	0,11	0,15	0,18
Uncracked concrete, Temperature range III: 120 °C / 72 °C						
Displacement	δ_{N0} [mm/kN]	0,03	0,04	0,05	0,06	0,08
	$\delta_{N\infty}$ [mm/kN]	0,07	0,10	0,12	0,16	0,20
Cracked concrete, Temperature range I: 40 °C / 24 °C						
Displacement	δ_{N0} [mm/kN]	0,06	0,07	0,08	0,09	0,10
	$\delta_{N\infty}$ [mm/kN]	0,21	0,21	0,21	0,21	0,21
Cracked concrete, Temperature range II: 80 °C / 50 °C						
Displacement	δ_{N0} [mm/kN]	0,07	0,08	0,08	0,10	0,11
	$\delta_{N\infty}$ [mm/kN]	0,23	0,23	0,23	0,23	0,23
Cracked concrete, Temperature range III: 120 °C / 72 °C						
Displacement	δ_{N0} [mm/kN]	0,07	0,08	0,09	0,11	0,12
	$\delta_{N\infty}$ [mm/kN]	0,25	0,25	0,25	0,25	0,25

¹⁾ Calculation of the displacement

$$\delta_{N0} = \delta_{N0\text{-factor}} \cdot N; \quad \delta_{N\infty} = \delta_{N\infty\text{-factor}} \cdot N; \quad (N: \text{applied tension load}).$$

Table C4: Displacements under shear load for HIT-Z (-F, -R) for static and quasi static loading¹⁾

		M8	M10	M12	M16	M20
Displacement	δ_{V0} [mm/kN]	0,06	0,06	0,05	0,04	0,04
	$\delta_{V\infty}$ [mm/kN]	0,09	0,08	0,08	0,06	0,06

¹⁾ Calculation of the displacement

$$\delta_{V0} = \delta_{V0\text{-factor}} \cdot V; \quad \delta_{V\infty} = \delta_{V\infty\text{-factor}} \cdot V; \quad (V: \text{applied shear load})$$

Injection system Hilti HIT-HY 200-R V3 with HIT-Z / HIT-Z-F / HIT-Z-R

Performances

Displacements in case of static and quasi-static loading

Annex C3

Table C5: Essential characteristics under tension load for HIT-Z (-F, -R) for seismic performance category C1

				M8	M10	M12	M16	M20
Installation factor	γ_{inst}	[-]		1,0				
Steel failure								
HIT-Z, HIT-Z-F	$N_{Rk,s,C1}$	[kN]		24	38	55	96	146
HIT-Z-R	$N_{Rk,s,C1}$	[kN]		24	38	55	96	146
Pull-out failure								
in cracked concrete C20/25								
Temperature range I:	40 °C / 24 °C	$N_{Rk,p,C1}$	[kN]	22	38	46	100	130
Temperature range II:	80 °C / 50 °C	$N_{Rk,p,C1}$	[kN]	20	34	42	90	115
Temperature range III:	120 °C / 72 °C	$N_{Rk,p,C1}$	[kN]	18	32	38	80	105

Table C6: Essential characteristics under shear load for HIT-Z (-F, -R) for seismic performance category C1

				M8	M10	M12	M16	M20
Factor without Hilti filling set	α_{gap}	[-]		0,5				
Factor with Hilti filling set	α_{gap}	[-]		1,0				
Steel failure								
HIT-Z, HIT-Z-F	$V_{Rk,s,C1}$	[kN]		8,5	12	16	28	45
HIT-Z-R	$V_{Rk,s,C1}$	[kN]		9,8	15	22	31	48

Injection system Hilti HIT-HY 200-R V3 with HIT-Z / HIT-Z-F / HIT-Z-R

Performances
Essential characteristics – seismic performance category C1

Annex C4

Table C7: Essential characteristics for HIT-Z (-F, -R) under tension load for seismic performance category C2

			M12	M16	M20
Installation factor	γ_{inst}	[-]	1,0		
Steel failure					
HIT-Z, HIT-Z-F	$N_{Rk,s,C2}$	[kN]	55	96	146
HIT-Z-R	$N_{Rk,s,C2}$	[kN]	55	96	146
Pull-out failure					
In cracked concrete C20/25					
Temperature range I: 40 °C / 24 °C	$N_{Rk,p,C2}$	[kN]	22	70	100
Temperature range II: 80 °C / 50 °C	$N_{Rk,p,C2}$	[kN]	19	60	80
Temperature range III: 120 °C / 72 °C	$N_{Rk,p,C2}$	[kN]	16	50	70

Table C8: Essential characteristics under shear load for HIT-Z (-F, -R) for seismic performance category C2

			M12	M16	M20
Factor without Hilti filling set	α_{gap}	[-]	0,5		
Factor with Hilti filling set	α_{gap}	[-]	1,0		
Steel failure					
Installation without Hilti filling set					
Effective embedment depth	h_{ef}	[mm]	< 96	< 125	< 150
HIT-Z, HIT-Z-F	$V_{Rk,s,C2}$	[kN]	11	17	35
HIT-Z-R	$V_{Rk,s,C2}$	[kN]	16	21	35
Effective embedment depth	h_{ef}	[mm]	≥ 96	≥ 125	≥ 150
HIT-Z ¹⁾ (-F, -R)	$V_{Rk,s,C2}$	[kN]	21	36	55
Installation with Hilti filling set					
Effective embedment depth	h_{ef}	[mm]	< 96	< 125	< 150
HIT-Z ¹⁾ (-F, -R)	$V_{Rk,s,C2}$	[kN]	20	34	40
Effective embedment depth	h_{ef}	[mm]	≥ 96	≥ 125	≥ 150
HIT-Z ¹⁾ (-F, -R)	$V_{Rk,s,C2}$	[kN]	23	41	61

¹⁾ These values apply only for steel elements shorter than HIT-Z M16x280 and HIT-Z M20x300.

Injection system Hilti HIT-HY 200-R V3 with HIT-Z / HIT-Z-F / HIT-Z-R

Performances

Essential characteristics and displacements – seismic performance category C2

Annex C5

Table C9: Displacements under tension load for HIT-Z (-F, -R) for seismic performance category C2

		M12	M16	M20
Displacement DLS	$\delta_{N,C2(DLS)}$ [mm]	1,3	1,9	1,2
Displacement ULS	$\delta_{N,C2(ULS)}$ [mm]	3,2	3,6	2,6

Table C10: Displacements under shear load for HIT-Z (-F, -R) for seismic performance category C2

		M12	M16	M20
Steel failure				
Installation without Hilti filling set				
Effective embedment depth	h_{ef} [mm]	< 96	< 125	< 150
Displacement DLS HIT-Z, HIT-Z-F	$\delta_{V,C2(DLS)}$ [mm]	2,8	3,1	4,9
Displacement ULS HIT-Z, HIT-Z-F	$\delta_{V,C2(ULS)}$ [mm]	4,6	6,2	6,8
Displacement DLS HIT-Z-R	$\delta_{V,C2(DLS)}$ [mm]	3,0	3,1	4,9
Displacement ULS HIT-Z-R	$\delta_{V,C2(ULS)}$ [mm]	6,2	6,2	6,8
Effective embedment depth	h_{ef} [mm]	≥ 96	≥ 125	≥ 150
Displacement DLS HIT-Z (-F, -R)	$\delta_{V,C2(DLS)}$ [mm]	3,4	3,6	4,6
Displacement ULS HIT-Z (-F, -R)	$\delta_{V,C2(ULS)}$ [mm]	6,0	5,9	5,8
Installation with Hilti filling set				
Effective embedment depth	h_{ef} [mm]	< 96	< 125	< 150
Displacement DLS HIT-Z (-F, -R)	$\delta_{V,C2(DLS)}$ [mm]	1,4	1,7	1,8
Displacement ULS HIT-Z (-F, -R)	$\delta_{V,C2(ULS)}$ [mm]	4,4	5,1	5,6
Effective embedment depth	h_{ef} [mm]	≥ 96	≥ 125	≥ 150
Displacement DLS HIT-Z (-F, -R)	$\delta_{V,C2(DLS)}$ [mm]	1,4	1,7	1,8
Displacement ULS HIT-Z (-F, -R)	$\delta_{V,C2(ULS)}$ [mm]	5,2	5,1	7,0

Injection system Hilti HIT-HY 200-R V3 with HIT-Z / HIT-Z-F / HIT-Z-R

Performances
Displacements for seismic performance category C2

Annex C6