



# HIT-HY 200 INJECTION MORTAR

**Technical Datasheet**

Update: Jan-23















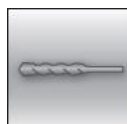

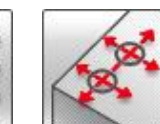

# HIT-HY 200 injection mortar

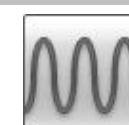
Anchor design (EN 1992-4) / Rods and Sleeves / Concrete

Injection mortar system		Benefits
	<p>Hilti HIT- HY 200-A</p> <p>500 ml foil pack (also available as 330 ml foil pack)</p>	<ul style="list-style-type: none"> <li>- <b>SafeSet</b> technology: Simplified method of borehole preparation using either Hilti hollow drill bit for hammer drilling or Roughening tool for diamond cored applications</li> </ul>
	<p>Hilti HIT- HY 200-R, HIT- HY 200-R V3</p> <p>500 ml foil pack (also available as 330 ml foil pack)</p>	<ul style="list-style-type: none"> <li>- Suitable for non-cracked and cracked concrete C 20/25 to C 50/60</li> <li>- ETA Approved for seismic performance category C1, C2<sup>a)</sup></li> </ul>
	<p>Anchor rod: HAS-U HAS-U HDG HAS-U A4 HAS-U HCR (M8-M30)</p>	<ul style="list-style-type: none"> <li>- Maximum load performance in cracked concrete and non-cracked concrete</li> <li>- 100 years service lifetime resistance<sup>b)</sup></li> </ul>
	<p>Internally threaded sleeve: HIS-N HIS-RN (M8-M20)</p>	<ul style="list-style-type: none"> <li>- Small edge distance and anchor spacing possible</li> <li>- Manual cleaning for borehole diameter up to 20mm and <math>h_{ef} \leq 10d</math> for non-cracked concrete only</li> </ul>
	<p>Anchor rod: HIT-Z HIT-Z-F HIT-Z-R (M8-M20)</p>	<ul style="list-style-type: none"> <li>- Three mortar versions: HY-200-R and HY-200-R V3 for slow cure applications and HY 200-A for fast cure applications</li> </ul>
	<p>Anchor rod: HAS-D (M12-M20)</p>	

a) HIS-N internally threaded sleeves not approved for Seismic.  
b) Only HIT-Z anchor rod has this feature.

Base material			Installation conditions					
 <p>Concrete (uncracked)</p>	 <p>Concrete (cracked)</p>	<p><b>100 YEARS</b> Design Life</p>	 <p>Hammer drilled holes</p>	 <p>Diamond drilled holes<sup>c)</sup></p>	 <p>Hilti <b>SafeSet</b> technology</p>	 <p>Variable embedment depth</p>	 <p>Small edge distance and spacing</p>	
Load conditions			Other information					
 <p>Static/ quasi-static</p>	 <p>Seismic, ETA-C1, C2<sup>a)</sup></p>	 <p>Fatigue ETA<sup>d)</sup></p>	 <p>Fire resistance</p>	 <p>European Technical Assessment</p>	 <p>CE conformity</p>	 <p>Corrosion resistance<sup>b)</sup></p>	 <p>High corrosion resistance<sup>b)</sup></p>	 <p>PROFIS Engineering Design Software</p>

a) HIS-N internally threaded sleeves not approved for Seismic category C2.  
b) High Corrosion resistant rods available only for HAS-U. Corrosion resistant rods available for HAS-U and HIS-N.  
c) Diamond drilling covered for HIT-Z rods. Diamond drilling only with Roughening Tool (RT) for HAS-U and HIS-N.  
d) Only for HAS-D rods.

### Approvals / certificates

Description	Product	Authority / Laboratory	No. / date of issue
European Technical Assessment <sup>a)</sup>	HY 200-A (Anchor)	DIBt, Berlin	ETA-11/0493 / 2022-10-12
European Technical Assessment <sup>a)</sup>	HY 200-A (HIT-Z)	DIBt, Berlin	ETA-12/0006 / 2020-10-28
European Technical Assessment <sup>a)</sup>	HY 200-R (Anchor)	DIBt, Berlin	ETA-12/0084 / 2022-10-12
European Technical Assessment <sup>a)</sup>	HY 200-R V3 (HIT-Z)	DIBt, Berlin	ETA-19/0632 / 2020-10-28
European Technical Assessment <sup>a)</sup>	HY 200-R (HIT-Z)	DIBt, Berlin	ETA-12/0028 / 2020-10-28
European Technical Assessment <sup>a)</sup>	HY 200-A/R/R V3 (HAS-D)	DIBt, Berlin	ETA-18/0972 / 2020-05-13
European Technical Assessment <sup>a)</sup>	HY 200-A/R/R V3 (HAS-D)	DIBt, Berlin	ETA-18/0978 / 2020-05-13
European Technical Assessment <sup>a)</sup>	HY 200-A (HIT-Z-D)	DIBt, Berlin	ETA-15/0296 / 2020-05-13
European Technical Assessment <sup>a)</sup>	HY 200-A (HIT-Z-D)	DIBt, Berlin	ETA-15/0802 / 2020-04-15
Shockproof fastenings in civil defence installations	HY 200-A/R	Federal Office for Civil Protection, Bern	BZS D 13-604 / 2013-12-31 BZS D 13-603 / 2013-12-31
Fire test report	HY 200-A/R	IBMB, Brunswick	3502/676/12 / 2017-09-15

a) All data given in this section according to the ETA approval for the product.

### Static and quasi-static resistance (for a single anchor)

#### All data in this section applies to:

- Correct setting (See setting instruction)
  - No edge distance and spacing influence
  - Steel failure
  - Minimum base material thickness
  - Embedment depth, as specified in the table
  - Anchor material, as specified in the tables
  - Concrete C 20/25
  - in-service temperature range I  
(min. base material temp. -40°C, max. long/short term base material temp.: +24°C/40°C)
  - Short term loading. For long term loading please apply  $\psi_{sUS} = 0.74^{b)}$
- b) HIT-Z and HAS-D are suitable for permanent loading without any load reduction.  $\psi_{sUS}$  is not considered for this element.

#### For hammer drilled holes, hammer drilled holes with Hilti hollow drill bit:

##### Embedment depth <sup>1)</sup> and base material thickness

Anchor size		M8	M10	M12	M16	M20	M24	M27	M30
<b>HAS-U</b>									
Embedment depth	$h_{ef}$ [mm]	80	90	110	125	170	210	240	270
Base material thickness	$h$ [mm]	110	120	140	160	220	270	300	340
<b>HIS-N</b>									
Embedment depth	$h_{ef}$ [mm]	90	110	125	170	205	-	-	-
Base material thickness	$h$ [mm]	120	150	170	230	270	-	-	-
<b>HIT-Z</b>									
Embedment depth	$h_{ef}$ [mm]	70	90	110	145	180	-	-	-
Base material thickness	$h$ [mm]	130	150	170	245	280	-	-	-
<b>HAS-D</b>									
Embedment depth	$h_{ef}$ [mm]	-	-	100	125	170	-	-	-
Base material thickness	$h$ [mm]	-	-	130	160	220	-	-	-

1) The allowed range of embedment depth is shown in the setting details.

**Characteristic resistance**

Anchor size		M8	M10	M12	M16	M20	M24	M27	M30
<b>Uncracked concrete</b>									
Tension	HAS-U 5.8	18,3	29,0	42,2	68,7	109,0	149,7	182,9	218,2
	HAS-U 8.8	29,3	42,0	56,8	68,7	109,0	149,7	182,9	218,2
	HAS-U A4	25,6	40,6	56,8	68,7	109,0	149,7	182,9	218,2
	HAS-U HCR	29,3	42,0	56,8	68,7	109,0	149,7	182,9	218,2
	HIS-N 8.8	25,0	46,0	67,0	109,0	116	-	-	-
	HIT-Z <sup>a)</sup>	24,0	38,0	50,0	85,9	118,8	-	-	-
	HAS-D	-	-	49,2	68,8	109,0	-	-	-
Shear	HAS-U 5.8	11,0	17,4	25,3	47,1	73,5	105,9	137,7	168,3
	HAS-U 8.8	14,6	23,2	33,7	62,8	98,0	141,2	183,6	224,4
	HAS-U A4	12,8	20,3	29,5	55,0	85,8	123,6	114,8	140,3
	HAS-U HCR	14,6	23,2	33,7	62,8	98,0	123,6	160,7	196,4
	HIS-N 8.8	13,0	23,0	34,0	63,0	58,0	-	-	-
	HIT-Z <sup>a)</sup>	12,0	19,0	27,0	48,0	73,0	-	-	-
	HAS-D	-	-	34,0	63,0	149,0	-	-	-
<b>Cracked concrete</b>									
Tension	HAS-U 5.8	15,1	21,2	35,2	48,1	76,3	104,8	128,0	152,8
	HAS-U 8.8	15,1	21,2	35,2	48,1	76,3	104,8	128,0	152,8
	HAS-U A4	15,1	21,2	35,2	48,1	76,3	104,8	128,0	152,8
	HAS-U HCR	15,1	21,2	35,2	48,1	76,3	104,8	128,0	152,8
	HIS-N 8.8	24,7	39,7	48,1	76,3	101,1	-	-	-
	HIT-Z <sup>a)</sup>	20,2	29,4	39,7	60,1	83,2	-	-	-
	HAS-D	-	-	34,4	48,1	76,3	-	-	-
Shear	HAS-U 5.8	11,0	17,4	25,3	47,1	73,5	105,9	137,7	168,3
	HAS-U 8.8	14,6	23,2	33,7	62,8	98,0	141,2	183,6	224,4
	HAS-U A4	12,8	20,3	29,5	55,0	85,8	123,6	114,8	140,3
	HAS-U HCR	14,6	23,2	33,7	62,8	98,0	123,6	160,7	196,4
	HIS-N 8.8	13,0	23,0	34,0	63,0	58,0	-	-	-
	HIT-Z <sup>a)</sup>	12,0	19,0	27,0	48,0	73,0	-	-	-
	HAS-D	-	-	34,0	63,0	149,0	-	-	-

a) Hilti anchor rod HIT-Z-F: M16 and M20.

**Design resistance**

Anchor size		M8	M10	M12	M16	M20	M24	M27	M30		
<b>Uncracked concrete</b>											
Tension	HAS-U 5.8	N <sub>Rd</sub>	[kN]	12,2	19,3	28,1	45,8	72,7	99,8	121,9	145,5
	HAS-U 8.8			19,5	28,0	37,8	45,8	72,7	99,8	121,9	145,5
	HAS-U A4			13,7	21,7	31,6	45,8	72,7	99,8	80,2	98,1
	HAS-U HCR			19,5	28,0	37,8	45,8	72,7	99,8	121,9	145,5
	HIS-N 8.8			16,7	30,7	44,7	72,7	77,3	-	-	-
	HIT-Z <sup>a)</sup>			16,0	25,3	33,3	57,3	79,2	-	-	-
	HAS-D			-	-	32,8	45,8	72,7	-	-	-
Shear	HAS-U 5.8	V <sub>Rd</sub>	[kN]	8,8	13,9	20,2	37,7	58,8	84,7	110,2	134,6
	HAS-U 8.8			11,7	18,6	27,0	50,2	78,4	113,0	146,9	179,5
	HAS-U A4			8,2	13,0	18,9	35,2	55,0	79,2	48,2	58,9
	HAS-U HCR			11,7	18,6	27,0	50,2	78,4	70,6	91,8	112,2
	HIS-N 8.8			10,4	18,4	27,2	50,4	46,4	-	-	-
	HIT-Z <sup>a)</sup>			9,6	15,2	21,6	38,4	58,4	-	-	-
	HAS-D			-	-	27,2	50,4	119,2	-	-	-
<b>Cracked concrete</b>											
Tension	HAS-U 5.8	N <sub>Rd</sub>	[kN]	10,0	14,1	23,5	32,1	50,9	69,9	85,4	101,8
	HAS-U 8.8			10,0	14,1	23,5	32,1	50,9	69,9	85,4	101,8
	HAS-U A4			10,0	14,1	23,5	32,1	50,9	69,9	80,2	98,1
	HAS-U HCR			10,0	14,1	23,5	32,1	50,9	69,9	85,4	101,8
	HIS-N 8.8			16,5	26,5	32,1	50,9	67,4	-	-	-
	HIT-Z <sup>a)</sup>			13,4	19,6	26,5	40,1	55,4	-	-	-
	HAS-D			-	-	22,9	32,1	50,9	-	-	-
Shear	HAS-U 5.8	V <sub>Rd</sub>	[kN]	8,8	13,9	20,2	37,7	58,8	84,7	110,2	134,6
	HAS-U 8.8			11,7	18,6	27,0	50,2	78,4	113,0	146,9	179,5
	HAS-U A4			8,2	13,0	18,9	35,2	55,0	79,2	48,2	58,9
	HAS-U HCR			11,7	18,6	27,0	50,2	78,4	70,6	91,8	112,2
	HIS-N 8.8			10,4	18,4	27,2	50,4	46,4	-	-	-
	HIT-Z <sup>a)</sup>			9,6	15,2	21,6	38,4	58,4	-	-	-
	HAS-D			-	-	27,2	50,4	101,8	-	-	-

a) Hilti anchor rod HIT-Z-F: M16 and M20.

**Recommended loads <sup>b)</sup>**

Anchor size				M8	M10	M12	M16	M20	M24	M27	M30
<b>Uncracked concrete</b>											
Tension	HAS-U 5.8	N <sub>Rd</sub>	[kN]	8,7	13,8	20,1	32,7	51,9	71,3	87,1	103,9
	HAS-U 8.8			13,9	20,0	27,0	32,7	51,9	71,3	87,1	103,9
	HAS-U A4			9,8	15,5	22,5	32,7	51,9	71,3	57,3	70,1
	HAS-U HCR			13,9	20,0	27,0	32,7	51,9	71,3	87,1	103,9
	HIS-N 8.8			11,9	21,9	31,9	51,9	55,2	-	-	-
	HIT-Z <sup>a)</sup>			11,4	18,1	23,8	40,9	56,6	-	-	-
	HAS-D			-	-	23,4	32,7	51,9	-	-	-
Shear	HAS-U 5.8	V <sub>Rd</sub>	[kN]	6,3	9,9	14,5	26,9	42,0	60,5	78,7	96,2
	HAS-U 8.8			8,4	13,3	19,3	35,9	56,0	80,7	104,9	128,2
	HAS-U A4			5,9	9,3	13,5	25,2	39,3	56,6	34,4	42,1
	HAS-U HCR			8,4	13,3	19,3	35,9	56,0	50,4	65,6	80,1
	HIS-N 8.8			7,4	13,1	19,4	36,0	33,1	-	-	-
	HIT-Z <sup>a)</sup>			6,9	10,9	15,4	27,4	41,7	-	-	-
	HAS-D			-	-	19,4	36,0	85,1	-	-	-
<b>Cracked concrete</b>											
Tension	HAS-U 5.8	N <sub>Rd</sub>	[kN]	7,2	10,1	16,8	22,9	36,3	49,9	61,0	72,7
	HAS-U 8.8			7,2	10,1	16,8	22,9	36,3	49,9	61,0	72,7
	HAS-U A4			7,2	10,1	16,8	22,9	36,3	49,9	57,3	70,1
	HAS-U HCR			7,2	10,1	16,8	22,9	36,3	49,9	61,0	72,7
	HIS-N 8.8			11,8	18,9	22,9	36,3	48,1	-	-	-
	HIT-Z <sup>a)</sup>			9,6	14,0	18,9	28,6	39,6	-	-	-
	HAS-D			-	-	16,4	22,9	36,3	-	-	-
Shear	HAS-U 5.8	V <sub>Rd</sub>	[kN]	6,3	9,9	14,5	26,9	42,0	60,5	78,7	96,2
	HAS-U 8.8			8,4	13,3	19,3	35,9	56,0	80,7	104,9	128,2
	HAS-U A4			5,9	9,3	13,5	25,2	39,3	56,6	34,4	42,1
	HAS-U HCR			8,4	13,3	19,3	35,9	56,0	50,4	65,6	80,1
	HIS-N 8.8			7,4	13,1	19,4	36,0	48,1	-	-	-
	HIT-Z <sup>a)</sup>			6,9	10,9	15,4	27,4	41,7	-	-	-
	HAS-D			-	-	19,4	36,0	72,7	-	-	-

a) Hilti anchor rod HIT-Z-F: M16 and M20;

b) With overall partial safety factor for action  $\gamma = 1,4$ . The partial safety factors for action depend on the type of loading and shall be taken from national regulations.

## Seismic resistance (for a single anchor)

### All data in this section applies to:

- Correct setting (See setting instruction with hammer drilling)
- No edge distance and spacing influence
- Steel failure
- Minimum base material thickness
- Concrete C 20/25
- Temperature range I (min. base material temp. -40°C, max. long/short term base material temp.: +24°C/40°C)
- Installation temperature range -10°C to +40°C (for HAS-U) or +5°C to +40°C (for HIT-Z)
- $\alpha_{\text{gap}} = 1,0$  (using Hilti seismic filling set) or  $\alpha_{\text{gap}} = 0,5$  (without using Hilti seismic filling set) accordingly

### For hammer drilled holes and hammer drilled holes with Hilti hollow drill bit:

#### Anchorage depth for seismic C2

Anchor size		M8	M10	M12	M16	M20	M24	M27	M30
<b>HAS-U</b>									
Embedment depth	$h_{\text{ef}}$ [mm]	-	-	-	125	170	210	-	-
Base material thickness	$h$ [mm]	-	-	-	160	220	270	-	-
<b>HIT-Z</b>									
Embedment depth	$h_{\text{ef}}$ [mm]	-	-	110	145	180	-	-	-
Base material thickness	$h$ [mm]	-	-	170	245	280	-	-	-

#### Characteristic resistance in case of seismic performance category C2

Anchor size		M8	M10	M12	M16	M20	M24	M27	M30	
Tension	HAS-U 8.8	$N_{\text{Rk,seis}}$ [kN]	-	-	-	24,5	45,9	55,4	-	-
	HIT-Z <sup>a)</sup>		-	-	22,0	51,1	70,7	-	-	-
<b>with Hilti filling set</b>										
Shear	HAS-U 8.8	$V_{\text{Rk,seis}}$ [kN]	-	-	-	46,0	77,0	103,0	-	-
	HIT-Z <sup>a)</sup>		-	-	23,0	41,0	61,0	-	-	-
<b>without Hilti filling set</b>										
Shear	HAS-U 8.8	$V_{\text{Rk,seis}}$ [kN]	-	-	-	20,0	35,5	45,0	-	-
	HIT-Z <sup>a)</sup>		-	-	10,5	18,0	27,5	-	-	-

a) Hilti anchor rod HIT-Z-F: M16 and M20.

#### Design resistance in case of seismic performance category C2

Anchor size		M8	M10	M12	M16	M20	M24	M27	M30	
Tension	HAS-U 8.8	$N_{\text{Rd,seis}}$ [kN]	-	-	-	16,3	30,6	36,9	-	-
	HIT-Z <sup>a)</sup>		-	-	14,7	34,1	47,1	-	-	-
<b>with Hilti filling set</b>										
Shear	HAS-U 8.8	$V_{\text{Rd,seis}}$ [kN]	-	-	-	36,8	61,6	82,4	-	-
	HIT-Z <sup>a)</sup>		-	-	18,4	32,8	48,8	-	-	-
<b>without Hilti filling set</b>										
Shear	HAS-U 8.8	$V_{\text{Rd,seis}}$ [kN]	-	-	-	16,0	28,4	36,0	-	-
	HIT-Z <sup>a)</sup>		-	-	8,4	14,4	22,0	-	-	-

a) Hilti anchor rod HIT-Z-F: M16 and M20.

### Anchorage depth for seismic C1

Anchor size			M8	M10	M12	M16	M20	M24	M27	M30
<b>HAS-U</b>										
Embedment depth	$h_{ef}$	[mm]	-	90	110	125	170	210	240	270
Base material thickness	$h$	[mm]	-	120	140	160	220	270	300	340
<b>HIT-Z</b>										
Embedment depth	$h_{ef}$	[mm]	70	90	110	145	180	-	-	-
Base material thickness	$h$	[mm]	130	150	170	245	280	-	-	-

### Characteristic resistance in case of seismic performance category C1

Anchor size			M8	M10	M12	M16	M20	M24	M27	M30
Tension	HAS-U 8.8	$N_{Rk,seis}$ [kN]	-	14,7	29,0	40,9	64,9	89,1	108,8	129,9
	HIT-Z <sup>a)</sup>		17,1	25,0	33,8	51,1	70,7	-	-	-
	HIT-Z-R		17,1	25,0	33,8	51,1	70,7	-	-	-
<b>with Hilti filling set</b>										
Shear	HAS-U 8.8	$V_{Rk,seis}$ [kN]	-	23,2	33,7	62,8	98,0	141,2	183,6	224,4
	HIT-Z <sup>a)</sup>		8,5	12,0	16,0	28,0	45,0	-	-	-
	HIT-Z-R		9,8	15,0	22,0	31,0	48,0	-	-	-
<b>without Hilti filling set</b>										
Shear	HAS-U 8.8	$V_{Rk,seis}$ [kN]	-	11,6	16,9	31,4	49,0	70,6	91,8	112,2
	HIT-Z <sup>a)</sup>		4,3	6,0	8,0	14,0	22,5	-	-	-
	HIT-Z-R		4,9	7,5	11,0	15,5	24,0	-	-	-

a) Hilti anchor rod HIT-Z-F: M16 and M20.

### Design resistance in case of seismic performance category C1

Anchor size			M8	M10	M12	M16	M20	M24	M27	M30
Tension	HAS-U 8.8	$N_{Rd,seis}$ [kN]	-	9,8	19,4	27,3	43,3	59,4	72,6	86,6
	HIT-Z <sup>a)</sup>		11,4	16,7	22,5	34,1	47,1	-	-	-
	HIT-Z-R		11,4	16,7	22,5	34,1	47,1	-	-	-
<b>with Hilti filling set</b>										
Shear	HAS-U 8.8	$V_{Rd,seis}$ [kN]	-	18,6	27,0	50,2	78,4	113,0	146,9	179,5
	HIT-Z <sup>a)</sup>		6,8	9,6	12,8	22,4	36,0	-	-	-
	HIT-Z-R		7,8	12,0	17,6	24,8	38,4	-	-	-
<b>without Hilti filling set</b>										
Shear	HAS-U 8.8	$V_{Rd,seis}$ [kN]	-	9,3	13,5	25,1	39,2	56,5	73,4	89,8
	HIT-Z <sup>a)</sup>		3,4	4,8	6,4	11,2	18,0	-	-	-
	HIT-Z-R		3,9	6,0	8,8	12,4	19,2	-	-	-

a) Hilti anchor rod HIT-Z-F: M16 and M20.

## Fatigue resistance

### All data in this section applies to:

- Correct setting (See setting instruction)
- No edge distance and spacing influence
- Steel failure
- Minimum base material thickness
- Concrete C 20/25
- In-service temperature range I

(min. base material temp. -40°C, max. long/short term base material temp.: +24°C/40°C)

### Anchorage depth

Anchor size			M12	M16	M20
<b>HAS-D</b>					
Embedment depth	$h_{ef}$	[mm]	100	125	170
Base material thickness	$h$	[mm]	130	160	220
<b>HIT-Z-D TP, HIT-Z-R-D TP</b>					
Embedment depth	$h_{ef}$	[mm]	-	125	-
Base material thickness <sup>a)</sup>	$h$	[mm]	-	160/225 <sup>a)</sup>	-

a) Values show for Drill hole condition (1) and (2) respectively. See setting details

### Characteristic resistance

Anchor size			M12	M16	M20
<b>Non-cracked concrete</b>					
Tension	HAS-D	$\Delta N_{Rk,0,\infty}$ [kN]	20,1	34,0	43,5
	HIT-Z-D TP		-	18,8	-
	HIT-Z-R-D TP		-	12,4	-
Shear	HAS-D	$\Delta V_{Rk,0,\infty}$ [kN]	8,2	15,0	21,1
	HIT-Z-D TP		-	8,0	-
	HIT-Z-R-D TP		-	8,0	-
<b>Cracked concrete</b>					
Tension	HAS-D	$\Delta N_{Rk,0,\infty}$ [kN]	20,1	34,0	43,5
	HIT-Z-D TP		-	18,8	-
	HIT-Z-R-D TP		-	12,4	-
Shear	HAS-D	$\Delta V_{Rk,0,\infty}$ [kN]	8,2	15,0	21,1
	HIT-Z-D TP		-	8,0	-
	HIT-Z-R-D TP		-	8,0	-

### Design resistance

Anchor size			M12	M16	M20
<b>Non-cracked concrete</b>					
Tension	HAS-D	$\Delta N_{Rd,0,\infty}$ [kN]	14,9	25,2	32,2
	HIT-Z-D TP		-	13,9	-
	HIT-Z-R-D TP		-	9,2	-
Shear	HAS-D	$\Delta V_{Rd,0,\infty}$ [kN]	6,1	11,1	15,6
	HIT-Z-D TP		-	5,9	-
	HIT-Z-R-D TP		-	5,9	-
<b>Cracked concrete</b>					
Tension	HAS-D	$\Delta N_{Rd,0,\infty}$ [kN]	14,9	25,2	32,2
	HIT-Z-D TP		-	13,9	-
	HIT-Z-R-D TP		-	9,2	-
Shear	HAS-D	$\Delta V_{Rd,0,\infty}$ [kN]	6,1	11,1	15,6
	HIT-Z-D TP		-	5,9	-
	HIT-Z-R-D TP		-	5,9	-



**Characteristic Wöhler curve under tension and shear fatigue load**

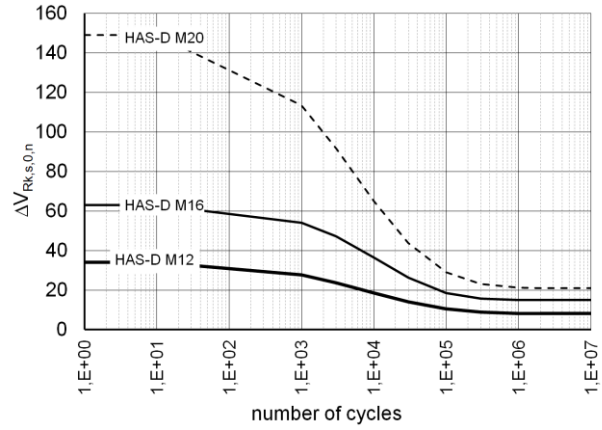
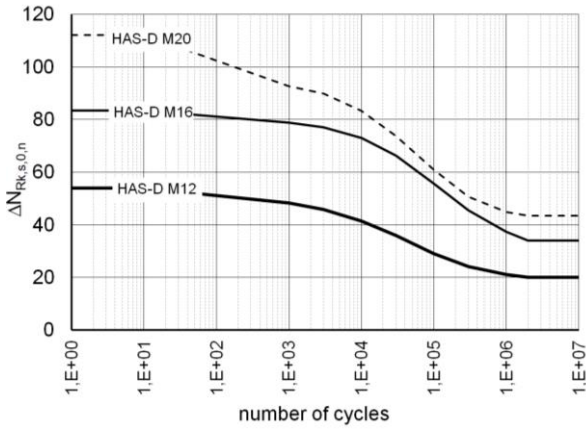

**Characteristic Wöhler curve under tension and shear fatigue load**

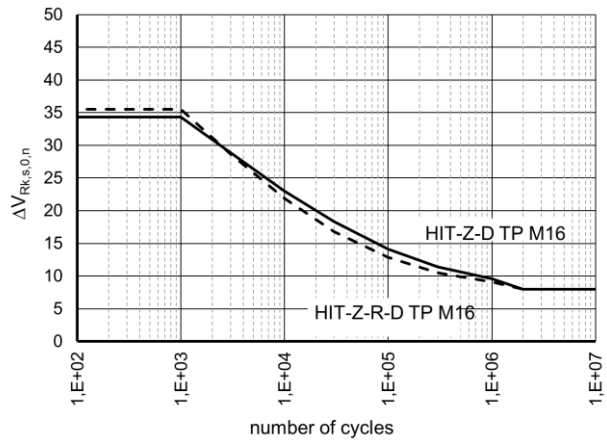
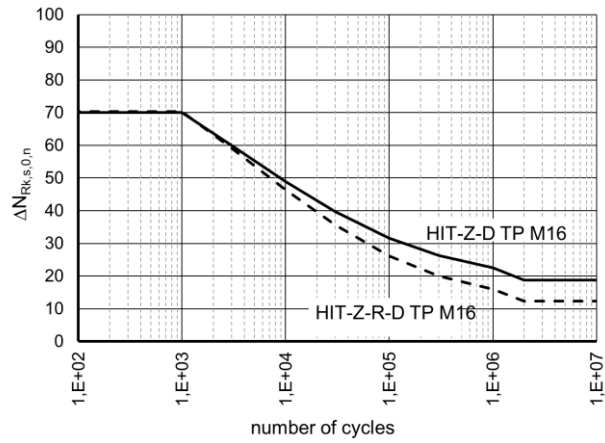

## Materials

### Mechanical properties for HAS-U

Anchor size				M8	M10	M12	M16	M20	M24	M27	M30
Nominal tensile strength	HAS-U 5.8 (HDG)	$f_{uk}$ [N/mm <sup>2</sup> ]		500	500	500	500	500	500	-	-
	HAS-U 8.8 (HDG)			800	800	800	800	800	800	800	800
	AM 8.8 (HDG)			700	700	700	700	700	700	500	500
	HAS-U A4			800	800	800	800	800	700	-	-
Yield strength	HAS-U 5.8 (HDG)	$f_{yk}$ [N/mm <sup>2</sup> ]		440	440	440	440	400	400	-	-
	HAS-U 8.8 (HDG)			640	640	640	640	640	640	640	640
	AM 8.8 (HDG)			450	450	450	450	450	450	210	210
	HAS-U A4			640	640	640	640	640	400	-	-
Stressed cross-section	HAS-U	$A_s$ [mm <sup>2</sup> ]	36,6	58,0	84,3	157	245	353	459	561	
Moment of resistance	HAS-U	$W$ [mm <sup>3</sup> ]	31,2	62,3	109	277	541	935	1387	1874	

### Mechanical properties for HIS-N

Anchor size				M8	M10	M12	M16	M20
Nominal tensile strength	HIS-N	$f_{uk}$ [N/mm <sup>2</sup> ]		490	490	490	490	490
	Screw 8.8			800	800	800	800	800
	HIS-RN			700	700	700	700	700
	Screw A4-70			700	700	700	700	700
Yield strength	HIS-N	$f_{yk}$ [N/mm <sup>2</sup> ]		390	390	390	390	390
	Screw 8.8			640	640	640	640	640
	HIS-RN			350	350	350	350	350
	Screw A4-70			450	450	450	450	450
Stressed cross-section	HIS-(R)N	$A_s$ [mm <sup>2</sup> ]		51,5	108	169	256	238
	Screw			36,6	58,0	84,3	157	245
Moment of resistance	HIS-(R)N	$W$ [mm <sup>3</sup> ]		145	430	840	1595	1543
	Screw			31,2	62,3	109	277	541

### Mechanical properties for HIT-Z

Anchor size				M8	M10	M12	M16	M20
Nominal tensile strength	HIT-Z(-F) <sup>a)</sup>	$f_{uk}$ [N/mm <sup>2</sup> ]		650	650	650	610	595
	HIT-Z-R			650	650	650	610	595
Yield strength	HIT-Z(-F) <sup>a)</sup>	$f_{yk}$ [N/mm <sup>2</sup> ]		520	520	520	490	480
	HIT-Z-R			520	520	520	490	480
Stressed cross-section of thread	HIT-Z(-F) <sup>a)</sup> HIT-Z-R	$A_s$ [mm <sup>2</sup> ]		36,6	58,0	84,3	157	245
Moment of resistance	HIT-Z(-F) <sup>a)</sup> HIT-Z-R	$W$ [mm <sup>3</sup> ]		31,9	62,5	109,7	278	542

a) Hilti anchor rod HIT-Z-F: M16 and M20.



### Material quality for HAS-U

Part	Material
<b>Zinc coated steel</b>	
Threaded rod, HAS-U 5.8 (HDG)	Strength class 5.8; Elongation at fracture A5 > 8% ductile Electroplated zinc coated $\geq 5\mu\text{m}$ ; (HDG) hot dip galvanized $\geq 45\mu\text{m}$
Threaded rod, HAS-U 8.8 (HDG)	Strength class 8.8; Elongation at fracture A5 > 12% ductile Electroplated zinc coated $\geq 5\mu\text{m}$ ; (HDG) hot dip galvanized $\geq 45\mu\text{m}$
Hilti Meter rod, AM 8.8 (HDG)	Strength class 8.8; Elongation at fracture A5 > 12% ductile Electroplated zinc coated $\geq 5\mu\text{m}$ (HDG) hot dip galvanized $\geq 45\mu\text{m}$
Washer	Electroplated zinc coated $\geq 5\mu\text{m}$ , hot dip galvanized $\geq 45\mu\text{m}$
Nut	Strength class of nut adapted to strength class of threaded rod. Electroplated zinc coated $\geq 5\mu\text{m}$ , (HDG) hot dip galvanized $\geq 45\mu\text{m}$
Hilti Filling set (F)	Filling washer: Electroplated zinc coated $\geq 5\mu\text{m}$ / (HDG) Hot dip galvanized $\geq 45\mu\text{m}$
	Spherical washer: Electroplated zinc coated $\geq 5\mu\text{m}$ / (HDG) Hot dip galvanized $\geq 45\mu\text{m}$
	Lock nut: Electroplated zinc coated $\geq 5\mu\text{m}$ / (HDG) Hot dip galvanized $\geq 45\mu\text{m}$
<b>Stainless Steel</b>	
Threaded rod, HAS-U A4	Strength class 70 for $\leq M24$ and strength class 50 for $> M24$ ; Elongation at fracture A5 > 8% ductile Stainless steel 1.4401; 1.4404; 1.4578; 1.4571; 1.4439; 1.4362 EN 10088-1:2014
Washer	Stainless steel 1.4401, 1.4404, 1.4578, 1.4571, 1.4439, 1.4362 EN 10088-1:2014
Nut	Stainless steel 1.4401, 1.4404, 1.4578, 1.4571, 1.4439, 1.4362 EN 10088-1:2014
<b>High corrosion resistant steel</b>	
Threaded rod, HAS-U HCR	Strength class 80 for $\leq M20$ and class 70 for $> M20$ , Elongation at fracture A5 > 8% ductile High corrosion resistant steel 1.4529, 1.4565 EN 10088-1:2014
Washer	High corrosion resistant steel 1.4529, 1.4565 EN 10088-1:2014
Nut	High corrosion resistant steel 1.4529, 1.4565 EN 10088-1:2014

### Material quality for HIS-N

Part	Material	
HIS-N	Int. threaded sleeve	Electroplated zinc coated $\geq 5\mu\text{m}$
	Screw 8.8	Strength class 8.8, A5 > 8 % Ductile; Steel galvanized $\geq 5\mu\text{m}$
HIS-RN	Int. threaded sleeve	Stainless steel 1.4401, 1.4571 EN 10088-1:2014
	Screw 70	Strength class 70, A5 > 8 % Ductile; Stainless steel 1.4401; 1.4404, 1.4578; 1.4571; 1.4439; 1.4362

### Material quality for HIT-Z

Part	Material
Threaded rod HIT-Z	Elongation at fracture > 8% ductile; Electroplated zinc coated $\geq 5\mu\text{m}$
Washer	Electroplated zinc coated $\geq 5\mu\text{m}$
Nut	Strength class of nut adapted to strength class of anchor rod. Electroplated zinc coated $\geq 5\mu\text{m}$
HIT-Z-F	Elongation at fracture > 8% ductile Multilayer coating, ZnNi-galvanized according to DIN 50979:2008-07
Washer	Multilayer coating, ZnNi-galvanized according to DIN 50979:2008-07
Nut	Multilayer coating, ZnNi-galvanized according to DIN 50979:2008-07
HIT-Z-R	Elongation at fracture > 8% ductile; Stainless steel 1.4401, 1.4404 EN 10088-1:2014
Washer	Stainless steel A4 according to EN 10088-1:2014
Nut	Strength class of nut adapted to strength class of anchor rod. Stainless steel 1.4401, 1.4404 EN 10088-1:2014

### Material quality for HAS-D

Part	Material
Fastener	Steel according to EN 10087:1998, galvanized and coated
Sealing washer	Steel, electroplated zinc coated $\geq 5 \mu\text{m}$
Calotte nut	Steel, electroplated zinc coated $\geq 5 \mu\text{m}$
Lock nut	Steel, electroplated zinc coated $\geq 5 \mu\text{m}$

### Setting information

#### Installation temperature:

- $-10\text{ °C}$  to  $+40\text{ °C}$  (for HAS-U, HAS-D, HIS-N)
- $+5\text{ °C}$  to  $+40\text{ °C}$  (for HIT-Z, HIT-Z-D)

#### In service temperature range

Hilti HIT-HY 200 A (R) injection mortar may be applied in the temperature ranges given below. An elevated base material temperature leads to a reduction of the design bond resistance.

#### Temperature in the base material

Temperature range	Base material temperature	Maximum long term base material temperature	Maximum short term base material temperature
Temperature range I	$-40\text{ °C}$ to $+40\text{ °C}$	$+24\text{ °C}$	$+40\text{ °C}$
Temperature range II	$-40\text{ °C}$ to $+80\text{ °C}$	$+50\text{ °C}$	$+80\text{ °C}$
Temperature range III	$-40\text{ °C}$ to $+120\text{ °C}$	$+72\text{ °C}$	$+120\text{ °C}$

#### Maximum short term base material temperature

Short-term elevated base material temperatures are those that occur over brief intervals, e.g. as a result of diurnal cycling.

#### Maximum long term base material temperature

Long-term elevated base material temperatures are roughly constant over significant periods of time.

### Curing and working time

Temperature of the base material <sup>a)</sup>	HIT-HY 200-A		HIT-HY 200-R		HIT-HY 200-R V3	
	Maximum working time	Minimum curing time	Maximum working time	Minimum curing time	Maximum working time	Minimum curing time
$T_{\text{BM}}$	$t_{\text{work}}$	$t_{\text{cure}}$	$t_{\text{work}}$	$t_{\text{cure}}$	$t_{\text{work}}$	$t_{\text{cure}}$
$-10\text{ °C} < T_{\text{BM}} \leq -5\text{ °C}$ <sup>a)</sup>	1,5 h	7 h	3 h	20 h	3 h	20 h
$-5\text{ °C} < T_{\text{BM}} \leq 0\text{ °C}$ <sup>a)</sup>	50 min	4 h	2 h	8 h	1,5 h	8 h
$0\text{ °C} < T_{\text{BM}} \leq 5\text{ °C}$ <sup>a)</sup>	25 min	2 h	1 h	4 h	45 min	4 h
$5\text{ °C} < T_{\text{BM}} \leq 10\text{ °C}$	15 min	75 min	40 min	2,5 h	30 min	2,5 h
$10\text{ °C} < T_{\text{BM}} \leq 20\text{ °C}$	7 min	45 min	15 min	1,5 h	15 min	1,5 h
$20\text{ °C} < T_{\text{BM}} \leq 30\text{ °C}$	4 min	30 min	9 min	1 h	9 min	1 h
$30\text{ °C} < T_{\text{BM}} \leq 40\text{ °C}$	3 min	30 min	6 min	1 h	6 min	1 h

a) Installation of HIT-Z, HIT-Z-D only in range  $+5\text{ °C}$  to  $+40\text{ °C}$

### Setting details for HAS-U

Anchor size			M8	M10	M12	M16	M20	M24	M27	M30
Nominal diameter of drill bit	$d_0$	[mm]	10	12	14	18	22	28	30	35
Effective embedment depth (= drill hole depth) <sup>a)</sup>	$h_{ef,min} = h_0$	[mm]	60	60	70	80	90	96	108	120
	$h_{ef,max} = h_0$	[mm]	160	200	240	320	400	480	540	600
Minimum base material thickness	$h_{min}$	[mm]	$h_{ef} + 30 \text{ mm} \geq 100 \text{ mm}$			$h_{ef} + 2 d_0$				
Maximum diameter of clearance hole in the fixture	$d_f$	[mm]	9	12	14	18	22	26	30	33
Thickness of Hilti filling set	$h_{fs}$	[mm]	-	-	-	11	13	15	-	-
Effective fixture thickness with Hilti filling set	$t_{fix,eff}$	[mm]	$t_{fix} - h_{fs}$							
Maximum torque moment <sup>b)</sup>	$T_{max}$	[Nm]	10	20	40	80	150	200	270	300
Minimum spacing	$s_{min}$	[mm]	40	50	60	75	90	115	120	140
Minimum edge distance	$c_{min}$	[mm]	40	45	45	50	55	60	75	80
Critical spacing for splitting failure	$s_{cr,sp}$	[mm]	$2 C_{cr,sp}$							
Critical edge distance for splitting failure <sup>c)</sup>	$c_{cr,sp}$	[mm]	$1,0 \cdot h_{ef}$		for $h / h_{ef} \geq 2,00$					
			$4,6 h_{ef} - 1,8 h$		for $2,0 > h / h_{ef} > 1,3$					
			$2,26 h_{ef}$		for $h / h_{ef} \leq 1,3$					
Critical spacing for concrete cone failure	$s_{cr,N}$	[mm]	$2 C_{cr,N}$							
Critical edge distance for concrete cone failure	$c_{cr,N}$	[mm]	$1,5 h_{ef}$							

For spacing (edge distance) smaller than critical spacing (critical edge distance) the design loads have to be reduced.

- a)  $h_{ef,min} \leq h_{ef} \leq h_{ef,max}$  ( $h_{ef}$ : embedment depth).
- b) Maximum recommended torque moment to avoid splitting failure during installation with minimum spacing and edge distance.
- c)  $h$ : base material thickness ( $h \geq h_{min}$ ).

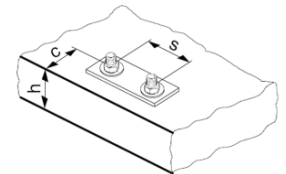

HAS-U-...



#### Marking:

Steel grade number and length identification letter: e.g. 8L

### Setting details for HIS-N

Anchor size		M8	M10	M12	M16	M20
Nominal diameter of drill bit	$d_0$ [mm]	14	18	22	28	32
Diameter of element	$d$ [mm]	12,5	16,5	20,5	25,4	27,6
Effective embedment depth (=drill hole depth)	$h_{ef} = h_0$ [mm]	90	110	125	170	205
Minimum base material thickness	$h_{min}$ [mm]	120	150	170	230	270
Diameter of clearance hole in the fixture	$d_f$ [mm]	9	12	14	18	22
Thread engagement length; min - max	$h_s$ [mm]	8-20	10-25	12-30	16-40	20-50
Maximum torque moment <sup>b)</sup>	$T_{max}$ [Nm]	10	20	40	80	150
Minimum spacing	$s_{min}$ [mm]	60	75	90	115	130
Minimum edge distance	$c_{min}$ [mm]	40	45	55	65	90
Critical spacing for splitting failure	$s_{cr,sp}$ [mm]	$2 C_{cr,sp}$				
Critical edge distance for splitting failure <sup>a)</sup>	$c_{cr,sp}$ [mm]	$1,0 \cdot h_{ef}$ for $h / h_{ef} \geq 2,0$				
		$4,6 h_{ef} - 1,8 h$ for $2,0 > h / h_{ef} > 1,3$				
		$2,26 h_{ef}$ for $h / h_{ef} \leq 1,3$				
Critical spacing for concrete cone failure	$s_{cr,N}$ [mm]	$2 C_{cr,N}$				
Critical edge distance for concrete cone failure	$c_{cr,N}$ [mm]	$1,5 h_{ef}$				

For spacing (edge distance) smaller than critical spacing (critical edge distance) the design loads have to be reduced.

a)  $h$ : base material thickness ( $h \geq h_{min}$ ).

b) Max. recommended torque moment to avoid splitting failure during Installation with minimum spacing and edge distance.

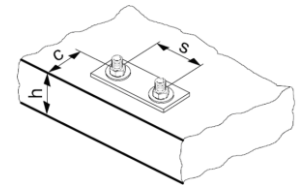
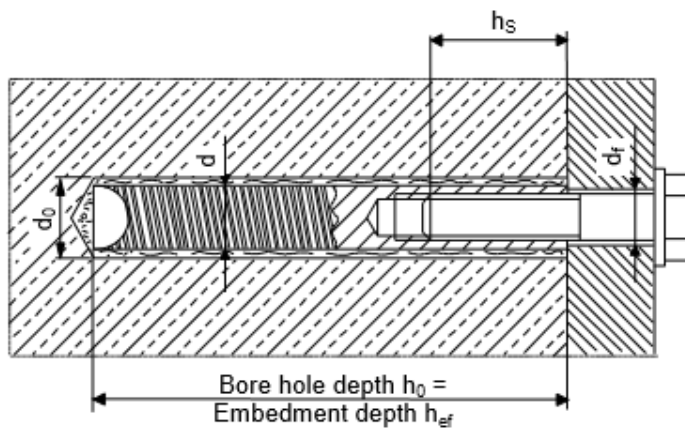

### Setting details for HIT-Z, HIT-Z-F and HIT-Z-R

Anchor size		M8	M10	M12	M16	M20
Nominal diameter of drill bit	$d_0$ [mm]	10	12	14	18	22
Length of anchor	min l [mm]	80	95	105	155	215
	max l [mm]	120	160	196	420	450
Nominal embedment depth <sup>a)</sup>	$h_{nom,min}$ [mm]	60	60	60	96	100
	$h_{nom,max}$ [mm]	100	120	144	192	220
Borehole condition 1 Min. base material thickness	$h_{min}$ [mm]	$h_{nom} + 60$ mm			$h_{nom} + 100$ mm	
Borehole condition 2 Min. base material thickness	$h_{min}$ [mm]	$h_{nom} + 30$ mm $\geq 100$ mm			$h_{nom} + 45$ mm	
Maximum depth of drill hole	$h_0$ [mm]	$h - 30$ mm			$h - 2 d_0$	
Pre-setting: Diameter of clearance hole in the fixture	$d_f$ [mm]	9	12	14	18	22
Through-setting: Diameter of clearance hole in the fixture	$d_f$ [mm]	11	14	16	20	24
Maximum fixture thickness	$t_{fix}$ [mm]	48	87	120	303	326
Maximum fixture thickness with seismic filling set	$t_{fix}$ [mm]	41	79	111	292	314
Installation torque moment <sup>b)</sup>	HIT-Z, HIT-Z-F $T_{inst}$ [Nm]	10	25	40	80	150
	HIT-Z-R $T_{inst}$ [Nm]	30	55	75	155	215
Critical spacing for splitting failure	$S_{cr,sp}$ [mm]	$2 C_{cr,sp}$				
Critical edge distance for splitting failure <sup>c)</sup>	$C_{cr,sp}$ [mm]	$1,5 \cdot h_{nom}$ for $h / h_{nom} \geq 2,35$				
		$6,2 h_{nom} - 2,0 h$ for $2,35 > h / h_{nom} > 1,35$				
		$3,5 h_{nom}$ for $h / h_{nom} \leq 1,35$				
Critical spacing for concrete cone failure	$S_{cr,N}$ [mm]	$2 C_{cr,N}$				
Critical edge distance concrete cone failure	$C_{cr,N}$ [mm]	$1,5 h_{nom}$				

For spacing (edge distance) smaller than critical spacing (critical edge distance) the design loads have to be reduced.

a)  $h_{nom,min} \leq h_{nom} \leq h_{nom,max}$  ( $h_{nom}$ : embedment depth).

b) Recommended torque moment to avoid splitting failure during instalation with minimum spacing and edge distance.

c)  $h$ : base material thickness ( $h \geq h_{min}$ ).

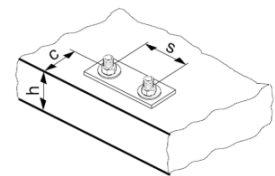

**Pre-setting:**

Install anchor before positioning fixture

**Through-setting:** Install anchor through positioned fixture

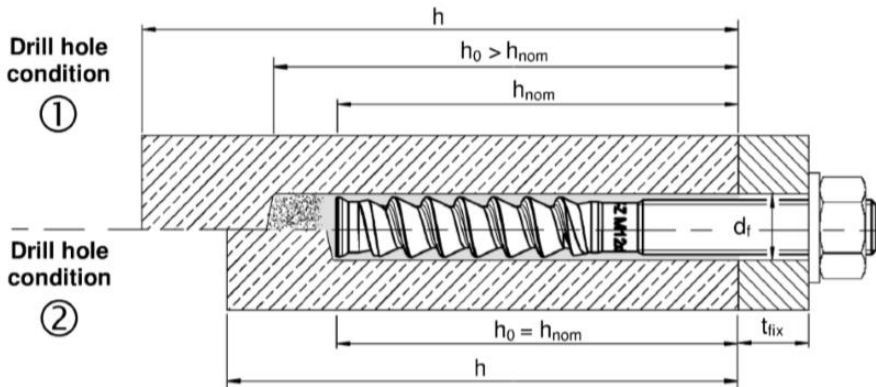

Drill hole condition 1 → non-cleaned borehole  
 Drill hole condition 2 → drilling dust is completely removed

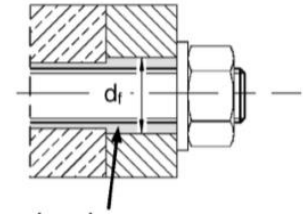

Annular gap filled with Hilti HIT-HY 200-A

**Anchor dimension for HIT-Z**

Anchor size			M8	M10	M12	M16	M20
Length of anchor	min $l$	[mm]	80	95	105	155	215
	max $l$		120	160	196	420	450
Helix length	$l_{\text{Helix}}$	[mm]	30 or 50	50 or 60	60	96	100

Combine with another table (setting details)

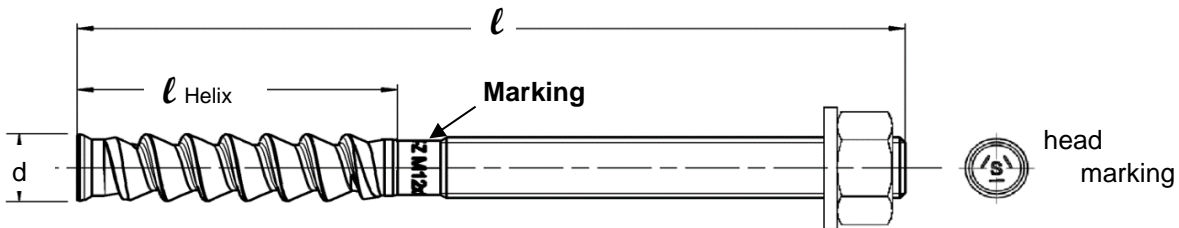

**Minimum edge distance and spacing for HIT-Z**

For the calculation of minimum spacing and minimum edge distance of anchors in combination with different embedment depth and thickness of concrete member the following equation shall be fulfilled:  $A_{i,req} < A_{i,cal}$

**Required interaction area  $A_{i,cal}$  for HIT-Z**

Anchor size			M8	M10	M12	M16	M20
Cracked concrete	[mm <sup>2</sup> ]		19200	40800	58800	94700	148000
Non-cracked concrete	[mm <sup>2</sup> ]		22200	57400	80800	128000	198000

Combine with another table (setting details)

### Effective area $A_{i,ef}$ of HIT-Z

#### Member thickness $h \geq h_{nom} + 1,5 \cdot c$

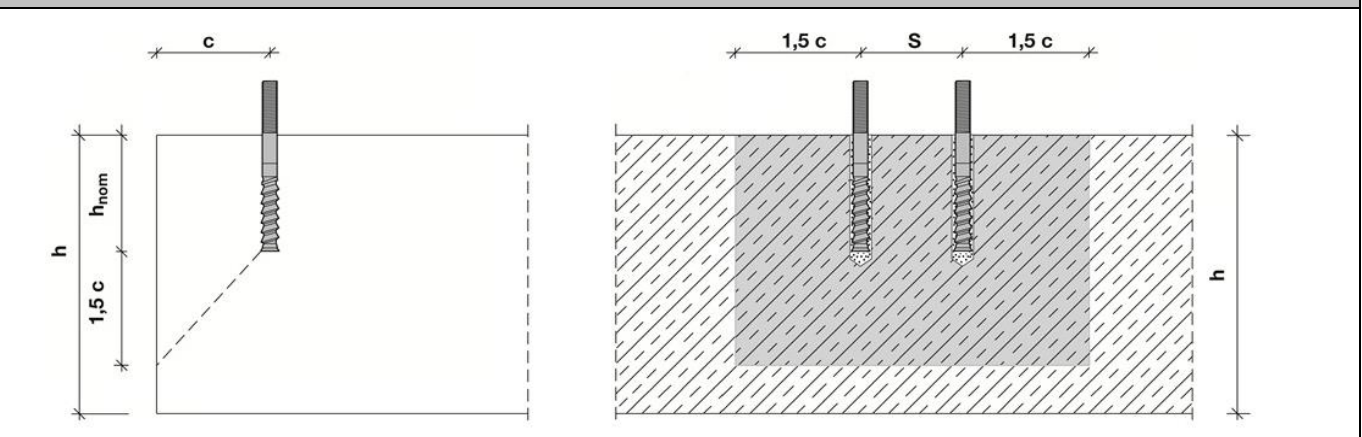

Single anchor and group of anchors with $s > 3 \cdot c$	[mm <sup>2</sup> ]	$A_{i,cal} = (6 \cdot c) \cdot (h_{nom} + 1,5 \cdot c)$	with $c \geq 5 \cdot d$
Group of anchors with $s \leq 3 \cdot c$	[mm <sup>2</sup> ]	$A_{i,cal} = (3 \cdot c + s) \cdot (h_{nom} + 1,5 \cdot c)$	with $c \geq 5 \cdot d$ and $s \geq 5 \cdot d$

#### Member thickness $h \leq h_{nom} + 1,5 \cdot c$

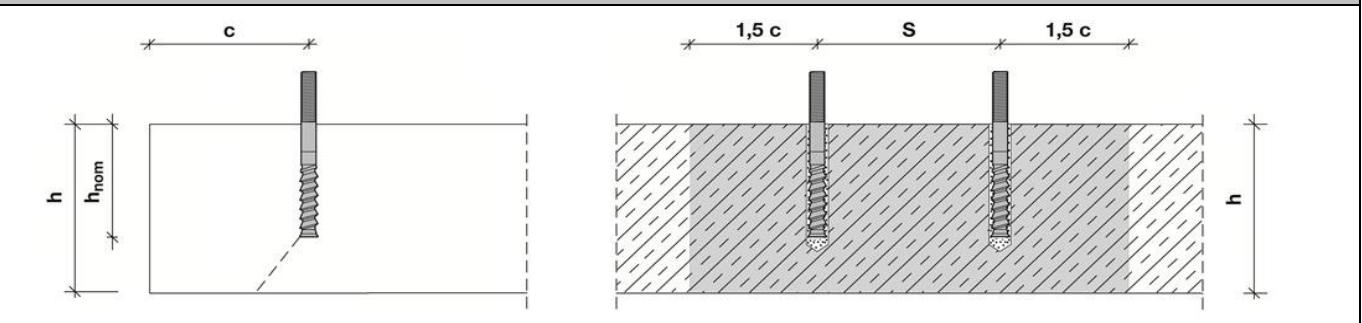

Single anchor and group of anchors with $s >$	[mm <sup>2</sup> ]	$A_{i,cal} = (6 \cdot c) \cdot h$	with $c \geq 5 \cdot d$
Group of anchors with $s \leq 3 \cdot c$	[mm <sup>2</sup> ]	$A_{i,cal} = (3 \cdot c + s) \cdot h$	with $c \geq 5 \cdot d$ and $s \geq 5 \cdot d$

### Best case minimum edge distance and spacing with required member thickness and embedment depth

Anchor size		M8	M10	M12	M16	M20
<b>Cracked concrete</b>						
Member thickness	$h \geq$ [mm]	140	200	240	300	370
Embedment depth	$h_{nom} \geq$ [mm]	80	120	150	200	220
Minimum spacing	$s_{min}$ [mm]	40	50	60	80	100
Corresponding edge distance	$c \geq$ [mm]	40	55	65	80	100
Minimum edge distance	$c_{min} =$ [mm]	40	50	60	80	100
Corresponding spacing	$s \geq$ [mm]	40	60	65	80	100
<b>Non-cracked concrete</b>						
Member thickness	$h \geq$ [mm]	140	230	270	340	410
Embedment depth	$h_{nom} \geq$ [mm]	80	120	150	200	220
Minimum spacing	$s_{min}$ [mm]	40	50	60	80	100
Corresponding edge distance	$c \geq$ [mm]	40	70	80	100	130
Minimum edge distance	$c_{min}$ [mm]	40	50	60	80	100
Corresponding spacing	$s \geq$ [mm]	40	145	160	160	235

**Best case minimum member thickness and embedment depth with required minimum edge distance and spacing (borehole condition 1)**

Anchor size		M8	M10	M12	M16	M20
<b>Cracked concrete</b>						
Member thickness	$h \geq$ [mm]	120	120	120	196	200
Embedment depth	$h_{nom} \geq$ [mm]	60	60	60	96	100
Minimum spacing	$s_{min}$ [mm]	40	50	60	80	100
Corresponding edge distance	$c \geq$ [mm]	40	100	140	135	215
Minimum edge distance	$c_{min} =$ [mm]	40	60	90	80	125
Corresponding spacing	$s \geq$ [mm]	40	160	220	235	365
<b>Non cracked concrete</b>						
Member thickness	$h \geq$ [mm]	120	120	120	196	200
Embedment depth	$h_{nom} \geq$ [mm]	60	60	60	96	100
Minimum spacing	$s_{min}$ [mm]	40	50	60	80	100
Corresponding edge distance	$c \geq$ [mm]	50	145	200	190	300
Minimum edge distance	$c_{min}$ [mm]	40	80	115	110	165
Corresponding spacing	$s \geq$ [mm]	65	240	330	310	495

**Minimum edge distance and spacing – Explanation**

Minimum edge and spacing geometrical requirements are determined by testing the installation conditions in which two anchors with a given spacing can be set close to an edge without forming a crack in the concrete due to tightening torque.

The HIT-Z boundary conditions for edge and spacing geometry can be found in the tables to the left. If the embedment depth and slab thickness are equal to or greater than the values in the table, then the edge and spacing values may be utilized.

**PROFIS Anchor software is programmed to calculate the referenced equations in order to determine the optimized related minimum edge and spacing based on the following variables:**

<b><u>Cracked or non-cracked concrete</u></b>	For cracked concrete it is assumed that a reinforcement is present which limits the crack width to 0,3 mm, allowing smaller values for minimum edge distance and minimum spacing
<b><u>Anchor diameter</u></b>	For smaller anchor diameter a smaller installation torque is required, allowing smaller values for minimum edge distance and minimum spacing
<b><u>Slab thickness and embedment depth</u></b>	Increasing these values allows smaller values for minimum edge distance and minimum spacing

### Setting details for HAS-D

Anchor size		M12	M16	M20
Nominal diameter of drill bit	$d_0$ [mm]	14	18	24
Diameter of element	$d = d_{nom}$ [mm]	12	16	20
Effective anchorage depth (=drill hole depth)	$h_{ef} = h_0$ [mm]	100	125	170
Minimum drill hole depth	$h_0$ [mm]	105	133	180
Minimum base material thickness	$h_{min}$ [mm]	130	160 <sup>1)</sup> / 170	220 <sup>1)</sup> / 230
Pre-setting: Maximum diameter of clearance hole in the fixture	$d_f$ [mm]	14	18	24
Through-setting: Maximum diameter of clearance hole in the fixture	$d_f$ [mm]	16	20	26
Fixture thickness	$t_{fix,min}$ [mm]	12	16	20
	$t_{fix,max}$ [mm]	200		
Installation torque moment	$T_{inst}$ [Nm]	30	50	80
Uncracked concrete	Minimum spacing	$s_{min}$ [mm]	80 <sup>2)</sup>	60
	Minimum edge distance	$c_{min}$ [mm]	55 <sup>2)</sup>	60
Cracked concrete	Minimum spacing	$s_{min}$ [mm]	50	60
	Minimum edge distance	$c_{min}$ [mm]	50	60

- 1) The reverse side of the concrete member shall have no break-through after drilling.  
 2) For min. edge distance  $c_{min} \geq 80$  mm, min. spacing  $s_{min} = 55$  mm.

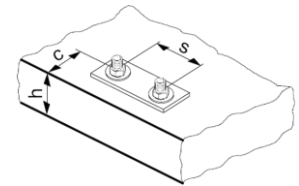
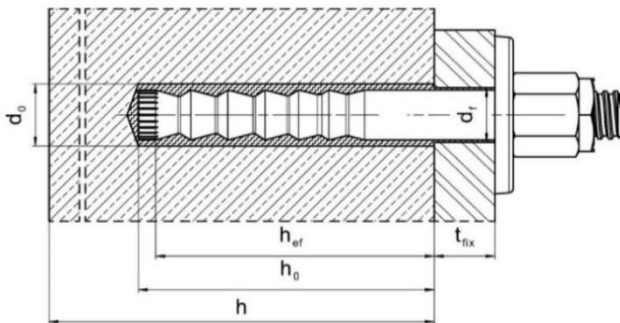

### Anchor dimension for HAS-D

Anchor size		M12	M16	M20
Shaft diameter	$d_k$ [mm]	12,5	16,5	22,0
Fastener length l	$\geq$ [mm]	143	180	242
	$\leq$ [mm]	531	565	623
Calotte nut	SW [mm]	18/19	24	30
Lock nut	SW [mm]	19	24	30

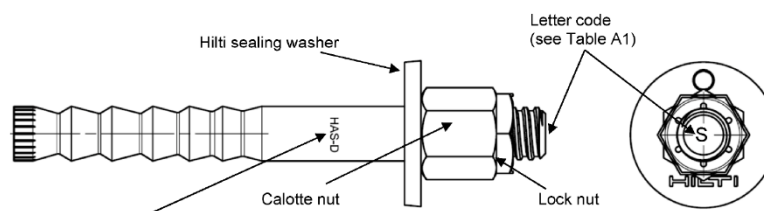

Marking:  
 HAS-D M...x L Bonded expansion anchor type as well as bonded expansion anchor size and length

### Installation equipment

Anchor size		M8	M10	M12	M16	M20	M24	M27	M30
Rotary hammer	HAS-U, HAS-D	TE 2 – TE 16				TE 40 - TE 80			
	HIT-Z	TE 2 – TE 40			TE 40 – TE 80		-		
	HIS-N	TE (-A) – TE 16(-A)		TE 40 – TE 80		-			
Other tools		blow out pump ( $h_{ef} \leq 10 \cdot d$ , $d_0 \leq 20$ mm) , compressed air gun, set of cleaning brushes, dispenser Hollow Drill Bit							
		roughening tools TE-YRT							
Additional Hilti recommended tools		DD EC-1, DD 100 ... DD 160 <sup>a)</sup>							

a) In case without roughentning – diamond coring is applicable only for HIT-Z installation

### Cleaning, drilling and installation parameters



HAS-U	HIT-Z, HIT-Z-D <sup>b)</sup>	HAS-D	HIS-N	Drilling				Cleaning and installation	
				Hammer drill (HD)	Hollow Drill Bit (HDB)	Diamond coring		Brush HIT-RB	Piston plug HIT-SZ
						Diamond coring (DD) <sup>c)</sup>	With roughening tool (RT)		
				$d_0$ [mm]				Size [mm]	
<b>M8</b>	<b>M8</b>	-	-	10	-	10	-	10	-
<b>M10</b>	<b>M10</b>	-	-	12	12	12	-	12	12
<b>M12</b>	<b>M12</b>	<b>M12</b>	<b>M8</b>	14	14	14	-	14	14
<b>M16</b>	<b>M16</b>	<b>M16</b>	<b>M10</b>	18	18	18	18	18	18
<b>M20</b>	<b>M20</b>	<b>M20</b>	<b>M12</b>	22 / 24 <sup>a)</sup>	22 / 24 <sup>a)</sup>	22 / 24 <sup>a)</sup>	22	22 / 24 <sup>a)</sup>	22 / 24 <sup>a)</sup>
<b>M24</b>	-	-	<b>M16</b>	28	28	28	28	28	28
<b>M27</b>	-	-	-	30	-	30	30	30	30
-	-	-	<b>M20</b>	32	32	32	32	32	32
<b>M30</b>	-	-	-	35	35	35	35	35	35

a) Only for HAS-D.

b) HIT-Z-D only available for M16.

c) Diamond cored holes without roughening can be used only for HIT-Z installation

### Associated components for the use of Hilti Roughening tool TE-YRT

Diamond coring		Roughening tool TE-YRT	Wear gauge RTG...
			
d <sub>0</sub> [mm]		d <sub>0</sub> [mm]	size
Nominal	measured		
18	17,9 to 18,2	18	18
20	19,9 to 20,2	20	20
22	21,9 to 22,2	22	22
25	24,9 to 25,2	25	25
28	27,9 to 28,2	28	28
30	29,9 to 30,2	30	30
32	31,9 to 32,2	32	32
35	34,9 to 35,2	35	35

### Installation parameters for use of the Hilti Roughening tool TE-YRT

h <sub>ef</sub> [mm]	Minimum roughening time t <sub>roughen</sub> [sec] (t <sub>roughen</sub> [sec] = h <sub>ef</sub> [mm] / 10)	Minimum blowing time t <sub>blowing</sub> [sec] (t <sub>blowing</sub> [sec] = t <sub>roughen</sub> [sec] + 20)
0 to 100	10	30
101 to 200	20	40
201 to 300	30	50
301 to 400	40	60
401 to 500	50	70
501 to 600	60	80

Setting instructions for HAS-U rods and HIS-N internally threaded sleeves

\*For detailed information on installation see instruction for use given with the package of the product



**Safety regulations.**

Review the Material Safety Data Sheet (MSDS) before use for proper and safe handling! Wear well-fitting protective goggles and protective gloves when working with Hilti HIT-HY 200 A (R).

**Drilling**

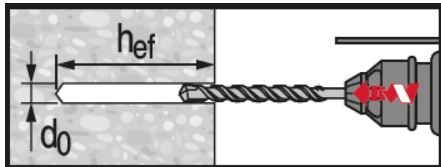

**Hammer drilled hole (HD)**

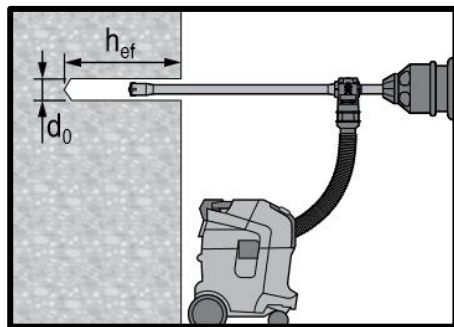

**Hammer drilled hole with Hollow Drilled Bit (HDB)**

No cleaning required

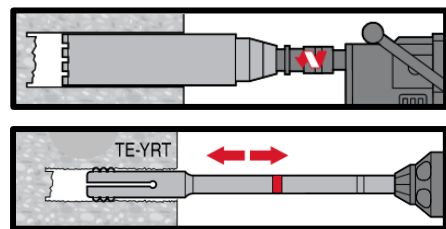

**Diamond Drilling + Roughening Tool (DD+RT)**

**Cleaning**

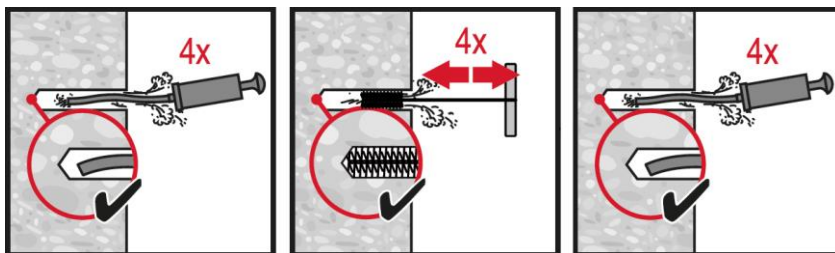

**Hammer drilling:**

**Manual cleaning (MC)**

for drill diameters  $d_0 \leq 20$  mm and drill hole depth  $h_0 \leq 10 \cdot d$ .

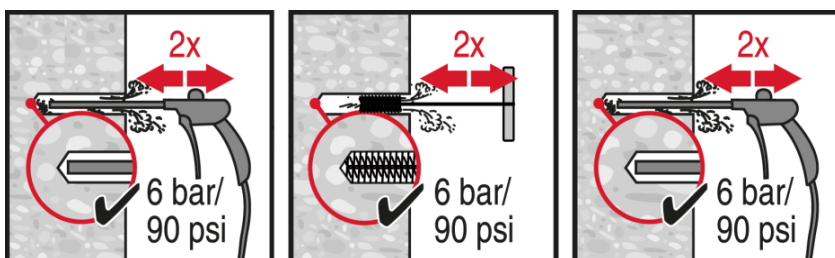

**Hammer drilling:**

**Compressed air cleaning (CAC)**

for all drill hole diameters  $d_0$  and drill hole depths  $h_0 \leq 20 \cdot d$ .

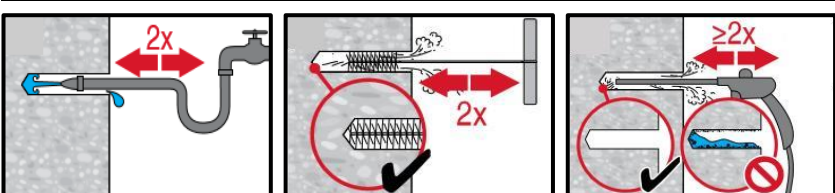

**Diamond cored holes with Hilti roughening tool:**

For all drill hole diameters  $d_0$  and drill hole depths  $h_0$ .

## Injection

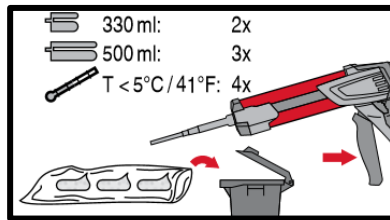
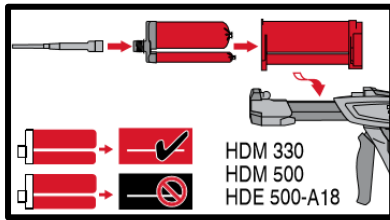

**Injection system preparation.**

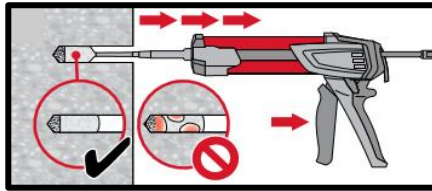
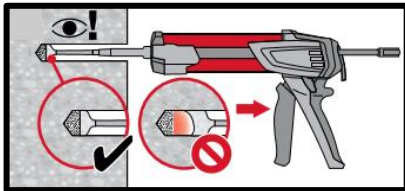

**Injection method for drill hole depth**  
 $h_{ef} \leq 250 \text{ mm}$ .

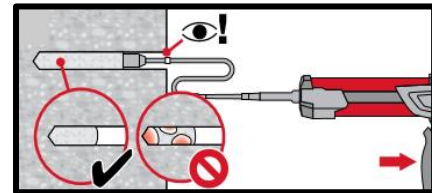
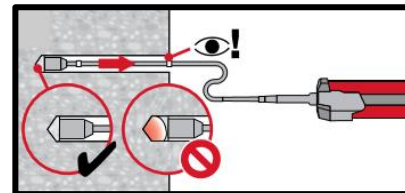

**Injection method for drill hole depth**  
 $h_{ef} > 250 \text{ mm}$ .

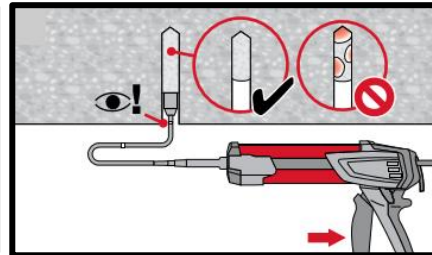
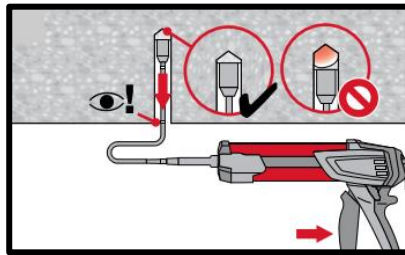

**Injection method for overhead**  
application and/or installation with  
embedment depth > 250 mm.

## Setting the element

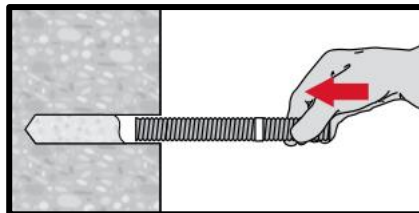

**Setting element**, observe working time  
“ $t_{work}$ ”.

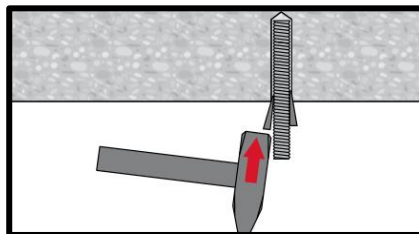

**Setting element** for overhead  
applications, observe working time “ $t_{work}$ ”.

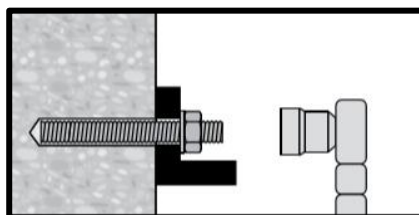

**Loading the anchor** after required  
curing time  $t_{cure}$

## Setting instructions for HIT-Z & HIT-Z(-D) rods

\*For detailed information on installation see instruction for use given with the package of the product.



### Safety regulations.

Review the Material Safety Data Sheet (MSDS) before use for proper and safe handling! Wear well-fitting protective goggles and protective gloves when working with Hilti HIT-HY 200 A (R)

### Drilling

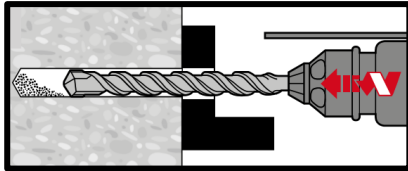

#### Hammer drilling: Through-setting

No cleaning required

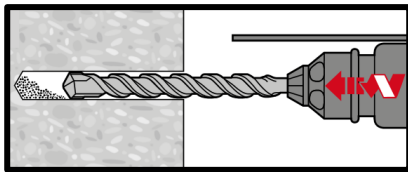

#### Hammer drilling: Pre-setting

No cleaning required

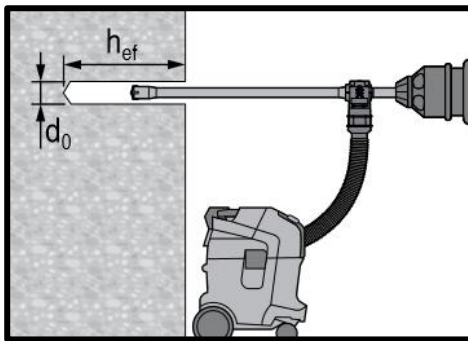

#### Hammer drilling with hollow drill bit: Through / pre-setting

No cleaning required

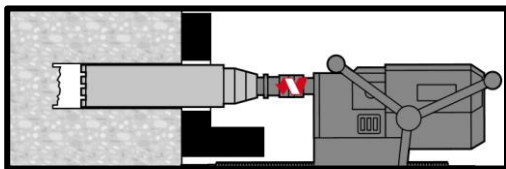

#### Diamond coring: Through-setting

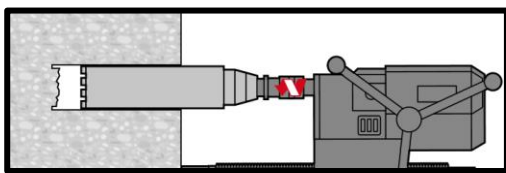

#### Diamond coring: Pre-setting

### Cleaning

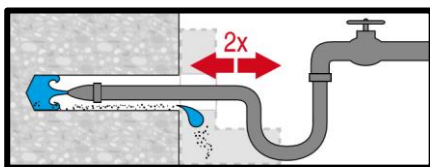

**Hole flushing** required for wet-drilled diamond cored holes.

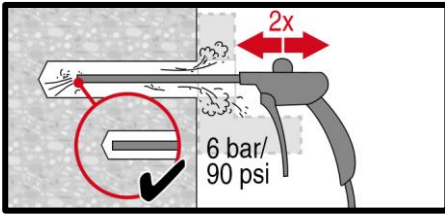

**Evacuation** required for wet-drilled diamond cored holes.

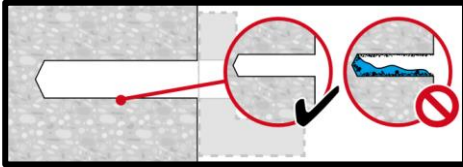

### Injection

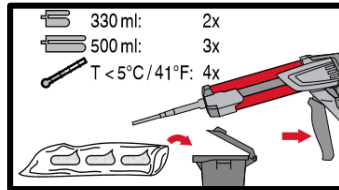
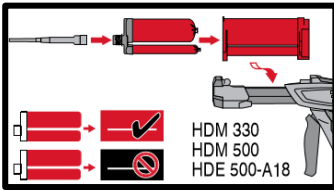

**Injection system preparation.**

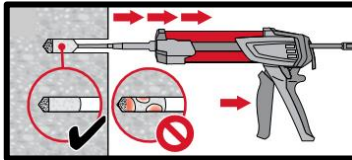
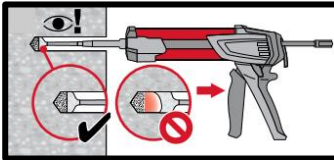

**Injection** of adhesive from the back of the drill hole without forming air voids.

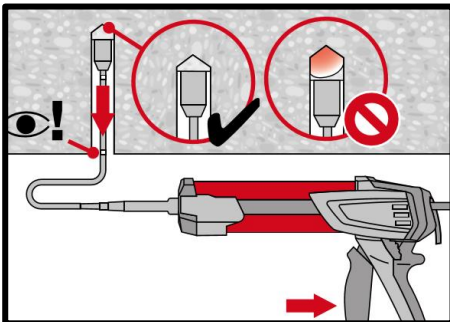

**Overhead installation** only with the aid of extensions and piston plugs.

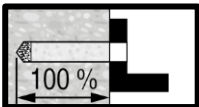

### Through-setting:

Fill 100% of the drill hole.



### Pre-setting:

Fill approx. 2/3 of the drill hole.

### Setting the element

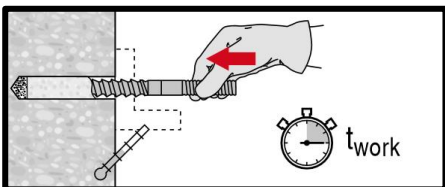

**Setting element** to the required embedment depth before working time " $t_{work}$ " has elapsed.

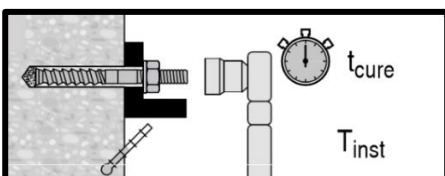

**Loading the anchor:** After required curing time  $t_{cure}$ .

## Setting instructions for HAS-D rods

\*For detailed information on installation see instruction for use given with the package of the product.



### Safety regulations.

Review the Material Safety Data Sheet (MSDS) before use for proper and safe handling! Wear well-fitting protective goggles and protective gloves when working with Hilti HIT-HY 200 A (R)

### Drilling

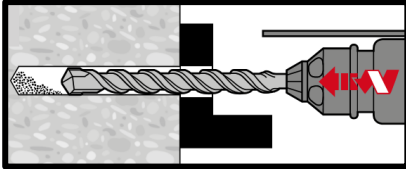

**Hammer drilling: Through-setting**

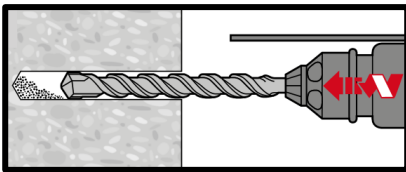

**Hammer drilling: Pre-setting**

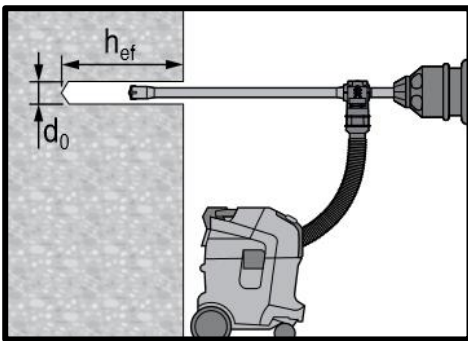

**Hammer drilling with hollow drill bit: Through / pre-setting**  
No cleaning required

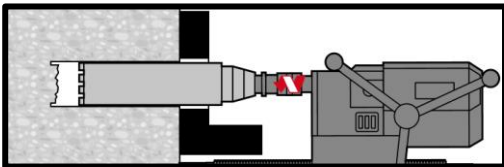

**Diamond coring: Through-setting**

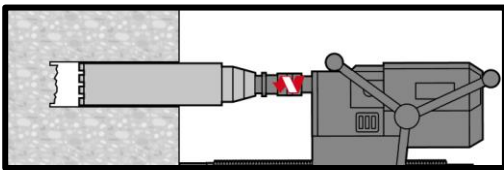

**Diamond coring: Pre-setting**

### Cleaning

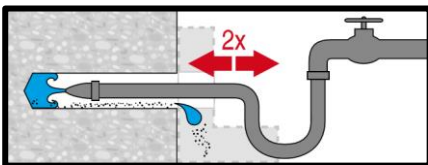

**Hole flushing** required for wet-drilled diamond cored holes.

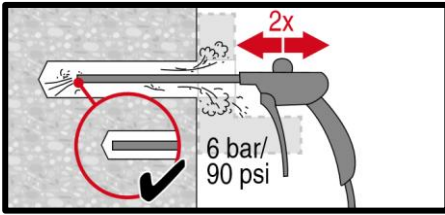

**Evacuation** required for wet-drilled diamond cored holes.

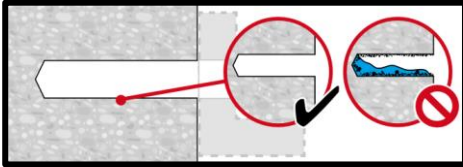

### Injection

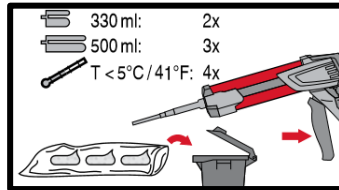
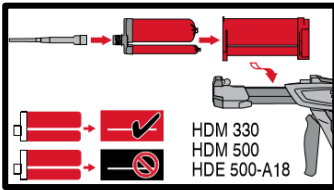

**Injection system preparation.**

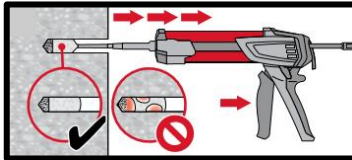
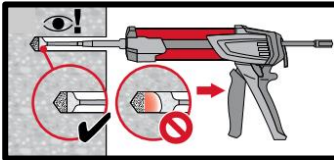

**Injection** of adhesive from the back of the drill hole without forming air voids.

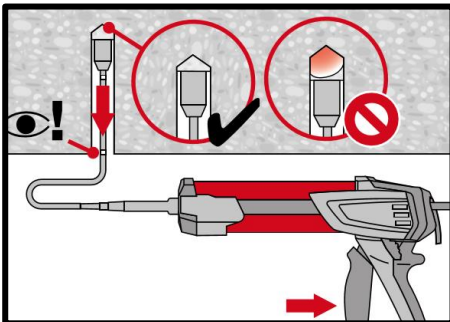

**Overhead installation** only with the aid of extensions and piston plugs.

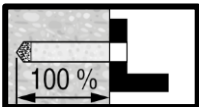

**Through-setting:**

Fill 100% of the drill hole.



**Pre-setting:**

Fill approx. 2/3 of the drill hole.

### Setting the element

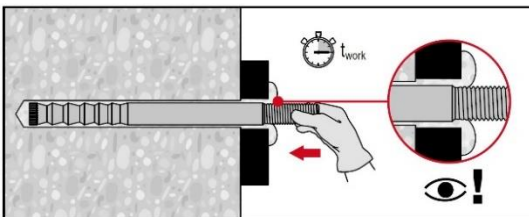

**Setting element** to the required embedment depth before working time " $t_{work}$ " has elapsed.

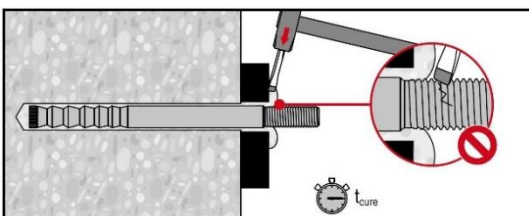

**Removing excess mortar:** After required curing time  $t_{cure}$ .

**Final assembly with sealing washer**

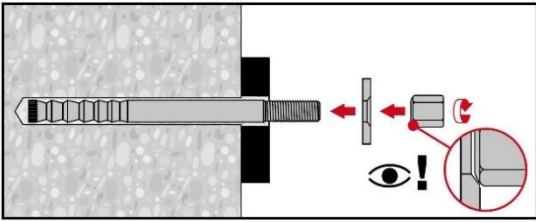

**Installation:** Orient the round part of the calotte nut to the sealing washer and install.

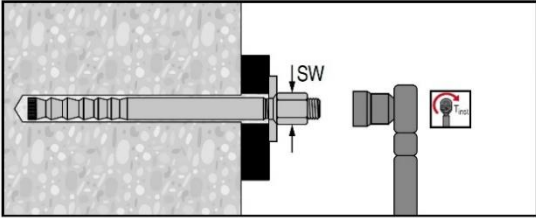

**Installation torque moment**

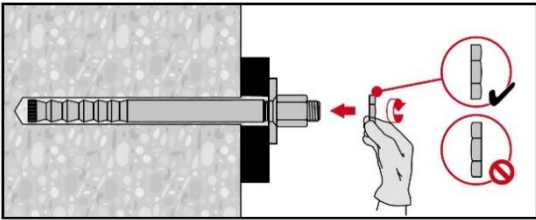

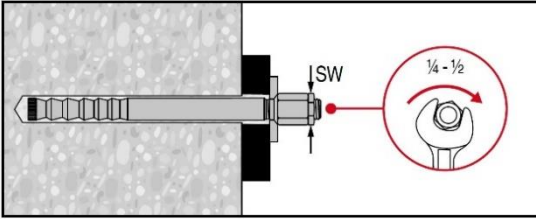

**Applying the lock nut:** Tighten with a ¼ to ½ turn.











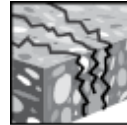

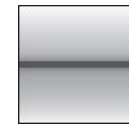

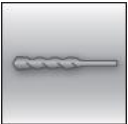

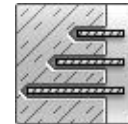
# HIT-HY 200 injection mortar

Anchor design (EN 1992-4) / Rebar elements / Concrete

Injection mortar system	Benefits
 <p>Hilti HIT - HY 200-A 330 ml foil pack (also available as 500 ml foil pack)</p>	<ul style="list-style-type: none"> <li>- <b>SafeSet</b> technology: Simplified method of borehole preparation using either Hilti hollow drill bit for hammer drilling or Roughening tool for diamond cored applications</li> <li>- ETA seismic approval C1</li> <li>- Suitable for cracked and non-cracked concrete C 20/25 to C 50/60</li> <li>- Suitable for dry and water saturated concrete</li> <li>- High loading capacity, excellent handling</li> <li>- Small edge distance and anchor spacing possible</li> <li>- In service temperature range up to 120°C short term / 72°C long term</li> <li>- Large diameter applications</li> <li>- Two mortar versions: HY 200-R for slow cure applications and HY 200-A for fast cure applications</li> </ul>
 <p>Hilti HIT - HY 200-R 330 ml foil pack (also available as 500 ml foil pack)</p>	
 <p>Rebar B500 B (<math>\phi 8</math> - <math>\phi 32</math>)</p>	

Base material	Load conditions						
 Concrete (non-cracked)	 Concrete (cracked)	 Dry concrete	 Wet concrete	 Static/ quasi-static	 Seismic, ETA-C1	 Fire resistance	
Installation conditions	Other informations						
 Hammer drilling	 Diamond drilled holes <sup>a)</sup>	 Variable embedment depth	 Hilti <b>SafeSet</b> technology	 Small edge distance and spacing	 European Technical Assessment	 CE conformity	 PROFIS Engineering design Software
<p>a) Diamond drilling only with Roughening Tool (RT).</p>							

### Approvals / certificates

Description	Product	Authority / Laboratory	No. / date of issue
European Technical Assessment <sup>a)</sup>	HY 200-A (Anchor)	DIBt, Berlin	ETA-11/0493 / 2019-08-30
European Technical Assessment <sup>a)</sup>	HY 200-R (Anchor)	DIBt, Berlin	ETA-12/0084 / 2019-08-28

a) All data given in this section according to ETA-11/0493 issue 2019-08-30 and to ETA-12/0084 issue 2019-08-28.

## Static and quasi-static loading (for a single anchor)

### All data in this section applies to

- Correct setting (See setting instruction)
- No edge distance and spacing influence
- Steel failure
- Base material thickness, as specified in the table
- Embedment depth, as specified in the table
- Anchor material, as specified in the tables
- Concrete C 20/25
- in-service temperate range I  
(min. base material temperature -40°C, max. long term/short term base material temperature: +24°C/40°C)
- Short term loading. For long term loading please apply  $\psi_{sus} = 0.74$

### Embedment depth <sup>a)</sup> and base material thickness

Anchor- size		φ8	φ10	φ12	φ14	φ16	φ20	φ25	φ26	φ28	φ30	φ32
Embedment depth	$h_{ef}$ [mm]	80	90	110	125	125	170	210	240	270	270	300
Base material thickness	$h$ [mm]	110	120	145	165	165	220	275	305	340	345	380

a) The allowed range of embedment depth is shown in the setting details.

### Characteristic resistance

Anchor- size			φ8	φ10	φ12	φ14	φ16	φ20	φ25	φ26	φ28	φ30	φ32
<b>Non-cracked concrete</b>													
Tensile	Rebar B500B	$N_{Rk}$ [kN]	24,1	33,9	49,8	66,0	68,7	109,0	149,7	182,9	218,2	218,2	255,6
Shear	Rebar B500B	$V_{Rk}$ [kN]	14,0	22,0	31,0	42,0	55,0	86,0	135,0	146,0	169,0	194,0	221,0
<b>Cracked concrete</b>													
Tensile	Rebar B500B	$N_{Rk}$ [kN]	-	14,1	29,0	38,5	44,0	74,8	104,8	128,0	152,8	152,8	178,9
Shear	Rebar B500B	$V_{Rk}$ [kN]	-	22,0	31,0	42,0	55,0	86,0	135,0	146,0	169,0	194,0	221,0

### Design resistance

Anchor- size			φ8	φ10	φ12	φ14	φ16	φ20	φ25	φ26	φ28	φ30	φ32
<b>Non-cracked concrete</b>													
Tensile	Rebar B500B	$N_{Rd}$ [kN]	16,1	22,6	33,2	44,0	45,8	72,7	99,8	121,9	145,5	145,5	170,4
Shear	Rebar B500B	$V_{Rd}$ [kN]	9,3	14,7	20,7	28,0	36,7	57,3	90,0	97,3	112,7	129,3	147,3
<b>Cracked concrete</b>													
Tensile	Rebar B500B	$N_{Rd}$ [kN]	-	9,4	19,4	25,7	29,3	49,8	69,9	85,4	101,8	101,8	119,3
Shear	Rebar B500B	$V_{Rd}$ [kN]	-	14,7	20,7	28,0	36,7	57,3	90,0	97,3	112,7	129,3	147,3

### Recommended loads <sup>a)</sup>

Anchor- size			φ8	φ10	φ12	φ14	φ16	φ20	φ25	φ26	φ28	φ30	φ32
<b>Non-cracked concrete</b>													
Tensile	Rebar B500B	$N_{Rec}$ [kN]	11,5	16,1	23,7	31,4	32,7	51,9	71,3	87,1	103,9	103,9	121,7
Shear	Rebar B500B	$V_{Rec}$ [kN]	6,7	10,5	14,8	20,0	26,2	41,0	64,3	69,5	80,5	92,4	105,2
<b>Cracked concrete</b>													
Tensile	Rebar B500B	$N_{Rec}$ [kN]	-	6,7	13,8	18,3	20,9	35,6	49,9	61,0	72,7	72,7	85,2
Shear	Rebar B500B	$V_{Rec}$ [kN]	-	10,5	14,8	20,0	26,2	41,0	64,3	69,5	80,5	92,4	105,2

a) With overall partial safety factor for action  $\gamma = 1.4$ . The partial safety factors for action depend on the type of loading and shall be taken from national regulations.

## Seismic loading (for a single anchor)

### All data in this section applies to:

- Correct setting (See setting)
- No edge distance and spacing influence
- Steel failure
- Minimum base material thickness
- Concrete C 20/25
- In-service temperate range I  
(min, base material temperature -40°C, max, long term/short term base material temperature: +24°C/40°C)
- $\alpha_{\text{gap}} = 1,0$

### Embedment depth and base material thickness in case of seismic performance category C1

Anchor- size			φ8	φ10	φ12	φ14	φ16	φ20	φ25	φ26	φ28	φ30	φ32
Typical embedment depth	$h_{\text{ef}}$	[mm]	-	90	110	125	125	170	210	240	270	270	300
Base material thickness	$h$	[mm]	-	120	145	165	165	220	275	305	340	345	380

### Characteristic resistance in case of seismic performance category C1

Anchor- size				φ8	φ10	φ12	φ14	φ16	φ20	φ25	φ26	φ28	φ30	φ32
Tensile	Rebar B500B	$N_{\text{Rk, seis}}$	[kN]	-	12,4	25,3	33,5	38,3	64,9	89,1	108,8	129,9	129,9	152,1
Shear	Rebar B500B	$V_{\text{Rk, seis}}$	[kN]	-	15,0	22,0	29,0	39,0	60,0	95,0	102,0	118,0	136,0	155,0

### Design resistance in case of seismic performance category C1

Anchor- size				φ8	φ10	φ12	φ14	φ16	φ20	φ25	φ26	φ28	φ30	φ32
Tensile	Rebar B500B	$N_{\text{Rd, seis}}$	[kN]	-	8,3	16,9	22,4	25,6	43,4	59,4	72,6	86,6	86,6	101,4
Shear	Rebar B500B	$V_{\text{Rd, seis}}$	[kN]	-	10,0	14,7	19,3	26,0	40,0	63,3	68,0	78,7	90,7	103,3

## Materials

### Mechanical properties

Anchor size		φ8	φ10	φ12	φ14	φ16	φ20	φ25	φ26	φ28	φ30	φ32
Nominal tensile strength	$f_{uk}$ [N/mm <sup>2</sup> ]	550	550	550	550	550	550	550	550	550	550	550
Yield strength	$f_{yk}$ [N/mm <sup>2</sup> ]	500	500	500	500	500	500	500	500	500	500	500
Stressed cross-section	$A_s$ [mm <sup>2</sup> ]	50,3	78,5	113	154	201	314	491	531	616	707	804
Moment of resistance	$W$ [mm <sup>3</sup> ]	50,3	98,2	170	269	402	785	1534	1726	2155	2651	3217

### Material quality

Part	Material
Rebar EN 1992-1-1:2004 and AC:2010	Bars and de-coiled rods class B or C according to NDP or NCL of EN 1992-1-1/NA:2013

## Setting information

### Installation temperature range

- 10°C to + 40°C

### Service temperature range

Hilti HIT-HY 200 injection mortar may be applied in the temperature ranges given below, An elevated base material temperature may lead to a reduction of the design bond resistance,

Temperature range	Base material temperature	Maximum long term base material temperature	Maximum short term base material temperature
Temperature range I	-40 °C to + 40 °C	+ 24 °C	+ 40 °C
Temperature range II	-40 °C to + 80 °C	+ 50 °C	+ 80 °C
Temperature range III	-40 °C to + 120 °C	+ 72 °C	+ 120 °C

### Maximum short term base material temperature

Short term elevated base material temperatures are those that occur over brief intervals, e.g, as a result of diurnal cycling,

### Maximum long term base material temperature

Long term elevated base material temperatures are roughly constant over significant periods of time,

## Curing and working time

Temperature of the base material	HIT-HY 200-A		HIT-HY 200-R	
	Maximum working time	Minimum curing time	Maximum working time	minimum curing time
$T_{BM}$	$t_{work}$	$t_{cure}$	$t_{work}$	$t_{cure}$
- 10°C < $T_{BM}$ ≤ - 5°C	1,5 h	7 h	3 h	20 h
- 5°C < $T_{BM}$ ≤ 0°C	50 min	4 h	2 h	8 h
0°C < $T_{BM}$ ≤ 5°C	25 min	2 hour	1 h	4 h
5°C < $T_{BM}$ ≤ 10°C	15 min	75 min	40 min	2,5 h
10°C < $T_{BM}$ ≤ 20°C	7 min	45 min	15 min	1,5 h
20°C < $T_{BM}$ ≤ 30°C	4 min	30 min	9 min	1 h
30°C < $T_{BM}$ ≤ 40°C	3 min	30 min	6 min	1 h

### Setting details

Anchor size		Ø8	Ø10	Ø12	Ø14	Ø16	Ø20	Ø25	Ø26	Ø28	Ø30	Ø32
Nominal diameter of drill bit	$d_0$ [mm]	10 / 12 <sup>a)</sup>	12 / 14 <sup>a)</sup>	14 / 16 <sup>a)</sup>	18	20	25	32	32	35	37	40
Effective anchorage depth (=drill hole depth) <sup>b)</sup>	$h_{ef,min} = h_0$ [mm]	60	60	70	75	80	90	100	104	112	120	128
	$h_{ef,max} = h_0$ [mm]	160	200	240	280	320	400	500	520	560	600	640
Minimum base material thickness	$h_{min}$ [mm]	$h_{ef} + 30 \text{ mm} \geq 100 \text{ mm}$			$h_{ef} + 2 d_0$							
Minimum spacing	$s_{min}$ [mm]	40	50	60	70	80	100	125	130	140	150	160
Minimum edge distance	$c_{min}$ [mm]	40	45	45	50	50	65	70	75	75	80	80
Critical spacing for splitting failure	$s_{cr,sp}$ [mm]	$2 c_{cr,sp}$										
Critical edge distance for splitting failure <sup>c)</sup>	$c_{cr,sp}$ [mm]	$1,0 \cdot h_{ef}$ for $h / h_{ef} \geq 2,0$										
		$4,6 h_{ef} - 1,8 h$ for $2,0 > h / h_{ef} > 1,3$										
		$2,26 h_{ef}$ for $h / h_{ef} \leq 1,3$										
Critical spacing for concrete cone failure	$s_{cr,N}$ [mm]	$2 c_{cr,N}$										
Critical edge distance for concrete cone failure	$c_{cr,N}$ [mm]	$1,5 h_{ef}$										

For spacing (edge distance) smaller than critical spacing (critical edge distance) the design loads have to be reduced,

- a) Both given values for drill bit diameter can be used.
- b)  $h_{ef,min} \leq h_{ef} \leq h_{ef,max}$  ( $h_{ef}$ : embedment depth).
- c)  $h$ : base material thickness ( $h \geq h_{min}$ ).

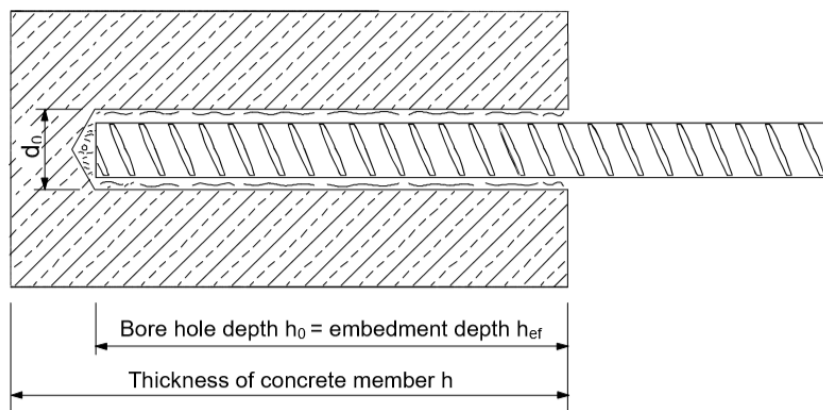
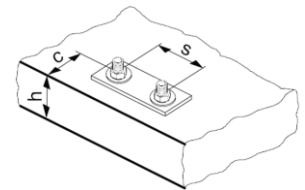

### Installation equipment

Anchor size	φ8	φ10	φ12	φ14	φ16	φ20	φ25	φ26	φ28	φ30	φ32
Rotary hammer	TE 2 (-A) – TE 16 (-A)					TE 40 – TE 80					
Other tools	blow out pump ( $h_{ef} \leq 10 \cdot d$ , $d_0 \leq 20$ mm), Compressed air gun, Set of cleaning brushes, dispenser										

### Drilling and cleaning diameters

Rebar	Drilling			Cleaning
	Hammer drill (HD)	Hollow Drill Bit (HDB)	Diamond coring with Roughening Tool (RT)	Brush HIT-RB
	$d_0$ [mm]			size [mm]
φ8	12 / 10 <sup>a)</sup>	12	-	12 / 10 <sup>a)</sup>
φ10	14 / 12 <sup>a)</sup>	14 / 12 <sup>a)</sup>	-	14 / 12 <sup>a)</sup>
φ12	16 / 14 <sup>a)</sup>	16 / 14 <sup>a)</sup>	-	16 / 14 <sup>a)</sup>
φ14	18	18	18	18
φ16	20	20	20	20
φ20	25	25	25	25
φ25	32	32	32	32
φ26	32	32	35	32
φ28	35	35	35	35
φ30	37	-	-	37
φ32	40	-	-	40

a) Both given values can be used.

### Associated components for the use of Hilti Roughening tool TE-YRT

Diamond coring		Roughening tool TE-YRT	Wear gauge RTG...
$d_0$ [mm]		$d_0$ [mm]	size
Nominal	measured		
18	17,9 to 18,2	18	18
20	19,9 to 20,2	20	20
22	21,9 to 22,2	22	22
25	24,9 to 25,2	25	25
28	27,9 to 28,2	28	28
30	29,9 to 30,2	30	30
32	31,9 to 32,2	32	32
35	34,9 to 35,2	35	35

### Installation parameters for use of the Hilti Roughening tool TE-YRT

$h_{ef}$ [mm]	Minimum roughening time $t_{roughen}$ [sec] ( $t_{roughen}$ [sec] = $h_{ef}$ [mm] / 10)	Minimum blowing time $t_{blowing}$ [sec] ( $t_{blowing}$ [sec] = $t_{roughen}$ [sec] + 20)
0 to 100	10	30
101 to 200	20	40
201 to 300	30	50
301 to 400	40	60
401 to 500	50	70
501 to 600	60	80

## Setting instructions

\*For detailed information on installation see instruction for use given with the package of the product,



### Safety regulations.

Review the Material Safety Data Sheet (MSDS) before use for proper and safe handling! Wear well-fitting protective goggles and protective gloves when working with Hilti HIT-HY 200.

## Drilling

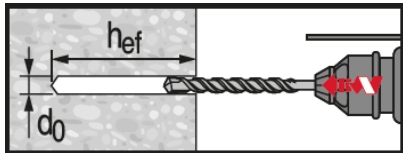

**Hammer drilled hole (HD)**

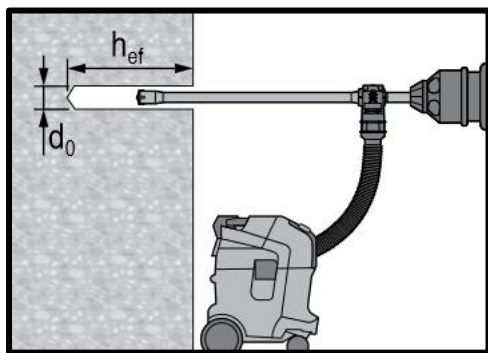

**Hammer drilled hole with Hollow Drilled Bit (HDB)**

No cleaning required

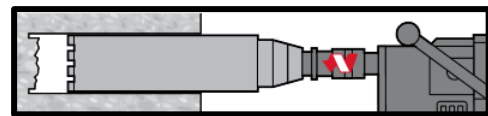

**Diamond Drilling + Roughening Tool (DD+RT)**

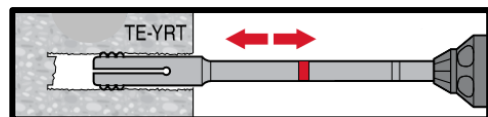

## Cleaning (Inadequate hole cleaning = poor load values.)

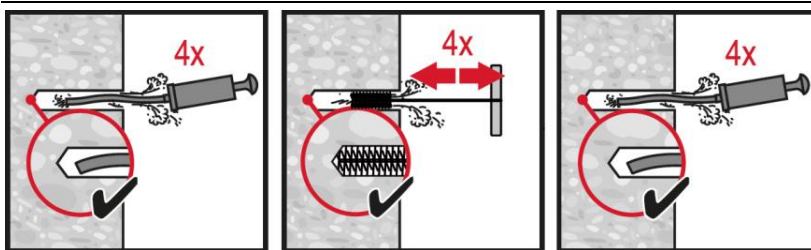

### Hammer drilling:

#### Manual cleaning (MC)

for drill diameters  $d_0 \leq 20$  mm and drill hole depth  $h_0 \leq 10 \cdot d$ .



### Hammer drilling:

#### Compressed air cleaning (CAC)

for all drill hole diameters  $d_0$  and drill hole depths  $h_0 \leq 20 \cdot d$ .

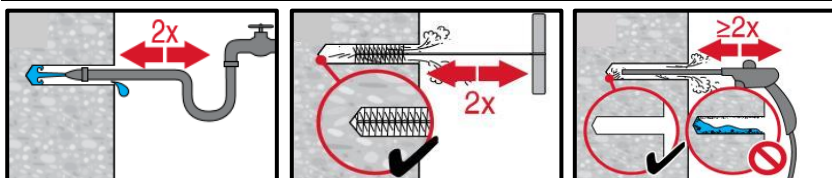

### Diamond cored holes with Hilti roughening tool:

For all drill hole diameters  $d_0$  and drill hole depths  $h_0$ .

**Injection system preparation**

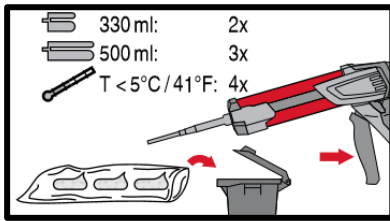
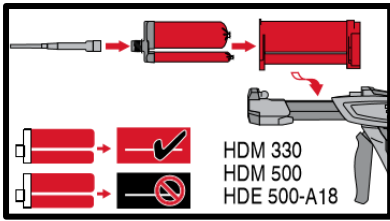

**Injection system preparation.**

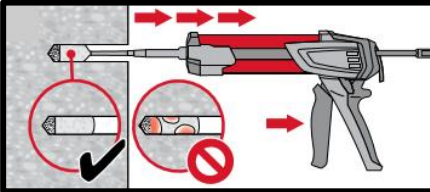
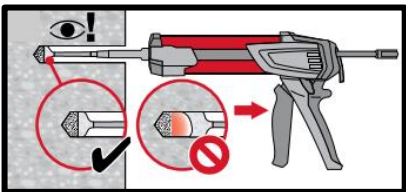

**Injection method for drill hole depth  $h_{ef} \leq 250$  mm.**

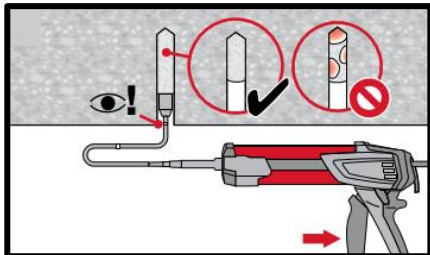
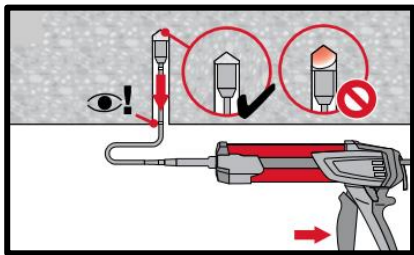

**Injection method for overhead application and/or installations with embedment depth  $h_{ef} \geq 250$  mm.**

**Setting the element**

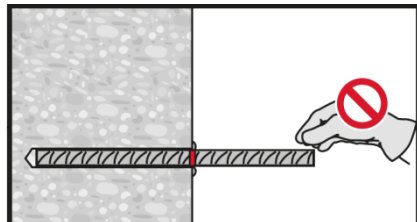
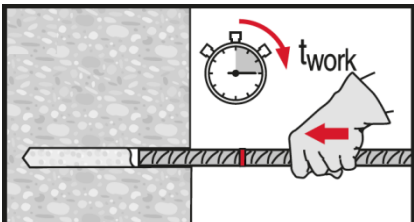

**Setting element, observe working time " $t_{work}$ ".**

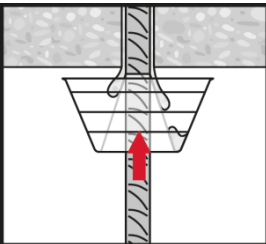
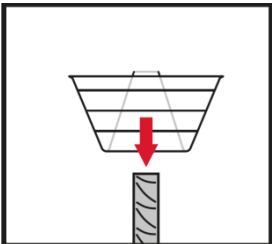
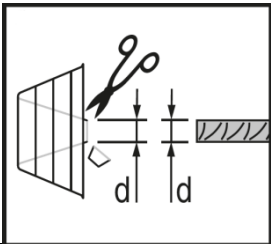

**Setting element for overhead applications, observe working time " $t_{work}$ ".**

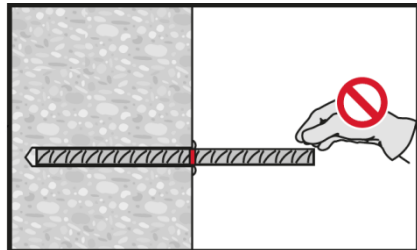
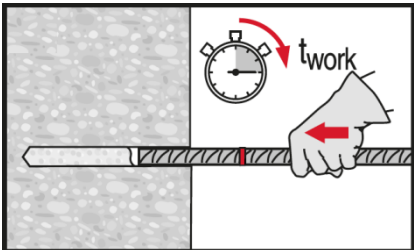

**Setting element, observe working time " $t_{work}$ ".**



# HIT-HY 200 injection mortar

Rebar design (EN 1992-1-1) / Rebar elements / Concrete

## Injection mortar system



Hilti HIT-HY 200-R  
330 ml foil pack  
(also available as  
500 ml foil pack)



Hilti HIT-HY 200-A  
330 ml foil pack  
(also available as  
500 ml foil pack)



Rebar  
( $\phi 8 - \phi 32$ )

## Benefits

- **SafeSet** technology: Simplified method of borehole preparation using either Hilti hollow drill bit for hammer drilling or Roughening tool for diamond cored applications
- HY 200-R version is formulated for best handling and cure time specifically for rebar applications
- Approved for ETA seismic C1 approval for post-installed-rebar
- Suitable for concrete C 12/15 to C 50/60
- Suitable for dry and water saturated concrete
- For rebar diameters up to 32 mm
- Non corrosive to rebar elements
- Good load capacity at elevated temperatures
- Suitable for embedment length up to 1000 mm
- Suitable for applications down to -10 °C
- Two mortar versions: HY 200-A for slow cure applications and HY 200-R for fast cure applications

## Base material



Concrete  
(non-cracked)



Concrete  
(cracked)

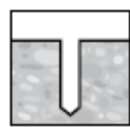

Dry concrete



Wet  
concrete



Static/  
quasi-static



Seismic<sup>a)</sup>



Fire resistance

## Load conditions

## Installation conditions

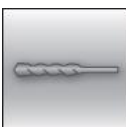

Hammer  
drilling



Diamond  
drilled holes<sup>b)</sup>



Hilti **SafeSet**  
technology

## Other informations



European  
Technical  
Assessment



CE  
conformity



PROFIS  
Engineering  
design  
Software

a) Seismic data only valid for HY 200-R.

b) Diamond drilling only with Roughening Tool (RT).

### Approvals / certificates

Description	Product	Authority / Laboratory	No. / date of issue
European Technical Assessment <sup>a)</sup>	HY 200-A (Rebar)	DIBt, Berlin	ETA-11/0492 / 2014-06-26
European Technical Assessment <sup>a)</sup>	HY 200-R (Rebar)	DIBt, Berlin	ETA-12/0083 / 2019-06-21
Assessment (fire)	HY 200-A	CSTB, Marne la Vallée	Z-21.8-1948 / 2013-11-14
Assessment (fire)	HY 200-R	CSTB, Marne la Vallée	Z-21.8-1947 / 2014-07-22

a) All data given in this section according to ETA-11/0492, issue 2014-06-26 and ETA-12/0083, issue 2019-06-21.

### Static and quasi-static loading

#### Static design acc. to EN 1992-1-1

#### Design bond strength in N/mm<sup>2</sup> for good bond conditions

All allowed drilling methods									
Rebar - size	Concrete class								
	C12/15	C16/20	C20/25	C25/30	C30/37	C35/45	C40/50	C45/55	C50/60
φ8 - φ32	1,6	2,0	2,3	2,7	3,0	3,4	3,7	4,0	4,3

For poor bond conditions multiply the values by 0,7. Values valid for non-cracked and cracked concrete.

#### Minimum anchorage length and minimum lap length

The minimum anchorage length  $\ell_{b,min}$  and the minimum lap length  $\ell_{0,min}$  according to EN 1992-1-1 shall be multiplied by relevant **Amplification factor**  $\alpha_{lb}$  in the table below.

#### Amplification factor $\alpha_{lb}$ for the min. anchorage length and min. lap length for

All allowed hammer drilling methods									
Rebar - size	Concrete class								
	C12/15	C16/20	C20/25	C25/30	C30/37	C35/45	C40/50	C45/55	C50/60
φ8 - φ32	1,0								

### Anchorage length for characteristic steel strength $f_{yk}=500 \text{ N/mm}^2$ for good conditions

All allowed drilling methods								
Rebar-size	Concrete class	Yielding load [kN]	$l_{b,min}^{1)}$ [mm]	$l_{0,min}^{1)}$ [mm]	$l_{bd,y} (\alpha_2=1)^{2)}$ [mm]	$l_{bd,y} (\alpha_2=0.7)^{3)}$ [mm]	$l_{max}^{-10^\circ C \leq c_t^{4)} \leq 0^\circ C}$ [mm]	$l_{max}^{c_t^{4)} > 0^\circ C}$ [mm]
φ8	C20/25	21,9	113	200	378	265	700	1000
φ8	C50/60	21,9	100	200	202	142	700	1000
φ10	C20/25	34,1	142	200	473	331	700	1000
φ10	C50/60	34,1	100	200	253	177	700	1000
φ12	C20/25	49,2	170	200	567	397	700	1000
φ12	C50/60	49,2	120	200	303	212	700	1000
φ14	C20/25	66,9	198	210	662	463	700	1000
φ14	C50/60	66,9	140	210	354	248	700	1000
φ16	C20/25	87,4	227	240	756	529	700	1000
φ16	C50/60	87,4	160	240	404	283	700	1000
φ18	C20/25	110,6	255	270	851	595	700	1000
φ18	C50/60	110,6	180	270	455	319	700	1000
φ20	C20/25	136,6	284	300	945	662	700	1000
φ20	C50/60	136,6	200	300	506	354	700	1000
φ22	C20/25	165,3	312	330	1040	728	700	1000
φ22	C50/60	165,3	220	330	556	389	700	1000
φ24	C20/25	196,7	340	360	1134	794	700	1000
φ24	C50/60	196,7	240	360	607	425	700	1000
φ25	C20/25	213,4	354	375	1181	827	700	1000
φ25	C50/60	213,4	250	375	632	442	700	1000
φ26	C20/25	230,8	369	390	1229	860	700	1000
φ26	C50/60	230,8	260	390	657	460	700	1000
φ28	C20/25	267,7	397	420	1323	926	700	1000
φ28	C50/60	267,7	280	420	708	495	700	1000
φ30	C20/25	307,3	425	450	1418	992	700	1000
φ30	C50/60	307,3	300	450	758	531	700	1000
φ32	C20/25	349,7	454	480	1512	1059	700	1000
φ32	C50/60	349,7	320	480	809	566	700	1000

- 1) According to EC2: EN 1992-1-1:2004  $l_{b,min}$  (8.6) and  $l_{0,min}$  (8.11) are calculated for good bond conditions with characteristic yield strength  $f_{yk} = 500 \text{ N/mm}^2$ ,  $\gamma_M=1,15$  and  $\alpha_6 = 1,0$ .
- 2) Embedment depth for yield of the rebar and for  $c_d/\phi = 1$  (characteristic yield strength  $f_{yk} = 500 \text{ N/mm}^2$ ).
- 3) Embedment depth for yield of the rebar and for  $c_d/\phi = 3$  (characteristic yield strength  $f_{yk} = 500 \text{ N/mm}^2$ ).
- 4)  $c_t$ =concrete temperature.

### Seismic data

#### Seismic data according to ETA-12/0083 assessment

#### Seismic reduction factor $k_{b,seis}$ for hammer drilling (HD) and (HDB) and compressed air drilling (CA)

Rebar - size	Reduction factor $k_{b,seis}$							
	Concrete class							
	C16/20	C20/25	C25/30	C30/37	C35/45	C40/50	C45/55	C50/60
φ12 - φ18	1,0				0,90	0,82	0,76	0,71
φ20 - φ30	1,0				0,92			0,86
φ32	1,0							

For poor bond conditions multiply the values 0,7.

Design values for the ultimate bond resistance  $f_{bd,seis}$  <sup>1)</sup> in N/mm<sup>2</sup> for seismic loading for hammer drilling (HD) and (HDB) and compressed air drilling (CA)

Rebar - size	Bond resistance $f_{bd,seis}$							
	Concrete class							
	C16/20	C20/25	C25/30	C30/37	C35/45	C40/50	C45/55	C50/60
$\phi 12 - \phi 18$	2,0	2,3	2,7	3,0				
$\phi 20 - \phi 30$	2,0	2,3	2,7	3,0	3,4	3,7		
$\phi 32$	2,0	2,3	2,7	3,0	3,4	3,7	4,0	4,3

1) According to EN 1992-1-1:2004 for good bond conditions. For all other bond conditions multiply the values by 0.7.

## Fire resistance

### a) Anchoring application

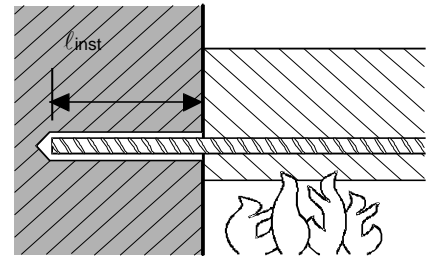

Maximum force ( $F_{s,T,max}$ ) in rebar in conjunction with HIT-HY 200 as a function of embedment depth ( $l_{inst}$ ) for the fire resistance classes R30 to R180 according to EC2.

Rebar-size	$F_{s,T,max}$ [kN]	$l_{inst}$ [mm]	Fire resistance of bar [kN]						
			R30	R60	R90	R120	R180		
$\phi 8$	16,19	80	3,0	0,7	0,2	0,0	0,0		
		120	7,0	2,2	1,3	0,7	0,2		
		170	16,2	16,2	16,2	10,2	9,2	4,0	1,7
		210				11,0	7,5		
		230				14,5	10,9		
		250				16,2	14,5		
		300				16,2	16,2		
$\phi 10$	25,29	100	6,1	2,0	1,0	0,4	0,0		
		150	19,3	9,3	7,1	2,2	1,0		
		190	25,3	25,3	25,3	18,0	15,9	9,3	4,9
		230				24,7	18,1	13,7	
		260				24,7	20,3		
		280				25,3	24,7		
		320				25,3	25,3		
$\phi 12$	36,42	120	15,3	6,0	1,9	1,1	0,3		
		180	31,0	19,0	17,8	8,5	7,0		

Maximum force ( $F_{s,T,max}$ ) in rebar in conjunction with HIT-HY 200 as a function of embedment depth ( $l_{inst}$ ) for the fire resistance classes F30 to F180 according to EC2

$\phi 12$	36,42	220	36,4	36,4	36,4	29,6	27,0	19,1	13,8
		260				29,7	24,4		
		280				35,0	29,6		
		300				36,4	34,9		
		340					36,4		
$\phi 14$	49,58	140	24,0	9,9	6,9	2,6	1,0		
		210	45,0	31,4	28,5	25,7	13,0		
		240	49,6	49,6	49,6	40,6	37,7	32,8	22,3
		280				40,7	34,6		

		300				44,7	40,7	
		330				49,6	48,1	
		360					49,6	
$\phi 16$	64,75	160	34,5	18,4	14,9	4,4	2,3	
		240	62,6	46,4	43,0	37,7	25,5	
		260	64,8	53,5	50,0	44,7	32,5	
		300		64,8	57,0	51,7	49,6	
		330			61,3	57,2		
		360	64,8	64,8	64,8	64,8	62,7	
		400				64,8	64,8	
$\phi 20$	101,18	200	60,7	40,0	36,3	29,3	14,3	
		250	78,3	62,5	58,3	51,3	36,3	
		310	101,2	88,9	84,6	77,6	62,6	
		350		101,2	101,2	94,2	80,2	
		370				101,2	83,5	
		390	101,2	101,2	101,2	101,2	97,8	
		430				101,2	101,2	
$\phi 25$	158,09	250	97,9	78,1	72,6	64,7	45,3	
		280	126,5	94,6	89,4	81,2	61,8	
		370	158,1	144,0	127,9	119,7	111,2	
		410		158,1	158,1	150,0	141,8	123,2
		430				150,0	144,2	
		450	158,1	158,1	158,1	158,1	155,2	
		500				158,1	158,1	
$\phi 32$	158,09	250	97,9	78,1	72,6	64,7	45,3	
		280	126,5	94,6	89,4	81,2	61,8	
		370	158,1	144,0	127,9	119,7	111,2	
		410		158,1	158,1	150,0	141,8	123,2
		430				150,0	144,2	
		450	158,1	158,1	158,1	158,1	155,2	
		500				158,1	158,1	

Characteristic yield strength  $f_{yk} = 500 \text{ N/mm}^2$   
Steel failure

## b) Overlap joint application

Max. bond stress,  $f_{bd, FIRE}$ , depending on actual clear concrete cover for classifying the fire resistance.

It must be verified that the actual force in the bar during a fire,  $F_{s,T}$ , can be taken up by the bar connection of the selected length,  $l_{inst}$ . Note: Cold design for ULS is mandatory.

$$F_{s,T} \leq (l_{inst} - c_f) \cdot \phi \cdot \pi \cdot f_{bd, FIRE} \quad \text{where: } (l_{inst} - c_f) \geq l_s;$$

$l_s$  = lap length

$\phi$  = nominal diameter of bar

$l_{inst} - c_f$  = selected overlap joint length; this must be at least  $l_s$ ,

but may not be assumed to be more than  $80 \phi$

$f_{bd, FIRE}$  = bond stress when exposed to fire

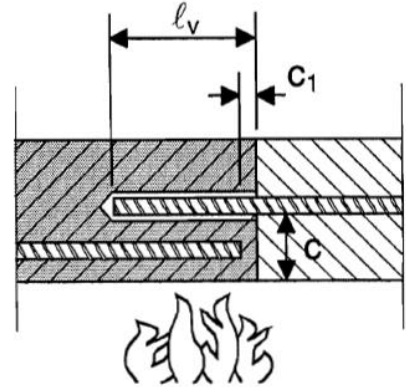

**Critical temperature-dependent bond stress,  $\tau_c$ , concerning “overlap joint” for Hilti HIT-HY 200 injection adhesive in relation to fire resistance class and required minimum concrete coverage c.**

Clear concrete cover c [mm]	Max. bond stress, $\tau_c$ [N/mm <sup>2</sup> ]						
	R30	R60	R90	R120	R180		
30	0,6	0,3	-	-	-		
35	0,7	0,3					
40	0,9	0,4	0,2				
45	1,0	0,4	0,2				
50	1,2	0,5	0,3				
55	1,5	0,6	0,3	0,2	-		
60	1,8	0,8	0,4	0,3			
65	2,2	0,9	0,5	0,3			
70		1,0	0,5	0,3			
75		1,2	0,6	0,4		0,2	
80		1,5	0,7	0,5		0,3	
85		1,7	0,8	0,5		0,3	
90		2,0	1,0	0,6		0,3	
95		2,2	2,2	1,1		0,7	0,4
100				1,3		0,8	0,4
105				1,5	0,9	0,5	
110				1,7	1,1	0,5	
115	2,0			1,2	0,6		
120	2,2	2,2	2,2	1,4	0,6		
125				1,6	0,7		
130				1,9	0,8		
135				2,1	0,9		
200					2,3		

## Materials

### Material quality

Part	Material
Rebar EN 1992-1-1	Bars and de-coiled rods class B or C with $f_{yk}$ and $k$ according to NDP or NCL of EN 1992-1-1 $f_{uk} = f_{tk} = k \cdot f_{yk}$

### Fitness for use

Some creep tests have been conducted in accordance with ETAG guideline 001 part 5 and TR 023 in the following conditions: **in dry environment at 50 °C during 90 days.**

These tests show an excellent behaviour of the post-installed connection made with HIT-HY 200: low displacements with long term stability, failure load after exposure above reference load.

### Resistance to chemical substances

Chemical	Resistance	Chemical	Resistance
Air	+	Gasoline	+
Acetic acid 10%	+	Glycole	o
Acetone	o	Hydrogen peroxide 10%	o
Ammonia 5%	+	Lactic acid 10%	+
Benzyl alcohol	-	Machinery oil	+
Chloric acid 10%	o	Methylethylketon	o
Chlorinated lime 10%	+	Nitric acid 10%	o
Citric acid 10%	+	Phosphoric acid 10%	+
Concrete plasticizer	+	Potassium Hydroxide pH 13,2	+
De-icing salt (Calcium chloride)	+	Sea water	+
Demineralized water	+	Sewage sludge	+
Diesel fuel	+	Sodium carbonate 10%	+
Drilling dust suspension pH 13,2	+	Sodium hypochlorite 2%	+
Ethanol 96%	-	Sulfuric acid 10%	+
Ethylacetate	-	Sulfuric acid 30%	+
Formic acid 10%	+	Toluene	o
Formwork oil	+	Xylene	o

- + resistant
- o resistant in short term (max. 48h) contact
- not resistant

### Electrical Conductivity

HIT-HY 200 in the hardened state **is not conductive electrically**. Its electric resistivity is  $15,5 \cdot 10^9 \Omega \cdot \text{cm}$  (DIN IEC 93 – 12.93). It is adapted well to realize electrically insulating anchoring (ex: railway applications, subway).

## Setting information

### Installation temperature range

-10°C to +40°C

### Service temperature range

Hilti HIT-HY 200 injection mortar may be applied in the temperature ranges given below. An elevated base material temperature may lead to a reduction of the design bond resistance.

Temperature range	Base material temperature	Maximum long term base material temperature	Maximum short term base material temperature
Temperature range I	-40 °C to +80 °C	+50 °C	+80 °C

### Maximum short term base material temperature

Short-term elevated base material temperatures are those that occur over brief intervals, e.g. as a result of diurnal cycling.

### Maximum long term base material temperature

Long-term elevated base material temperatures are roughly constant over significant periods of time.

### Curing and working time

Temperature of the base material	HIT-HY 200-A		HIT-HY 200-R	
	Maximum working time	Minimum curing time	Maximum working time	Minimum curing time
$T_{BM}$	$t_{work}$	$t_{cure}$	$t_{work}$	$t_{cure}$
$-10^{\circ}\text{C} < T_{BM} \leq -5^{\circ}\text{C}$	1,5 h	7 h	3 h	20 h
$-5^{\circ}\text{C} < T_{BM} \leq 0^{\circ}\text{C}$	50 min	4 h	2 h	8 h
$0^{\circ}\text{C} < T_{BM} \leq 5^{\circ}\text{C}$	25 min	2 hour	1 h	4 h
$5^{\circ}\text{C} < T_{BM} \leq 10^{\circ}\text{C}$	15 min	75 min	40 min	2,5 h
$10^{\circ}\text{C} < T_{BM} \leq 20^{\circ}\text{C}$	7 min	45 min	15 min	1,5 h
$20^{\circ}\text{C} < T_{BM} \leq 30^{\circ}\text{C}$	4 min	30 min	9 min	1 h
$30^{\circ}\text{C} < T_{BM} \leq 40^{\circ}\text{C}$	3 min	30 min	6 min	1 h

## Setting information

### Installation equipment

Rebar – size	φ8 - φ16	φ18 - φ32
Rotary hammer	TE 2 (-A)– TE 40(-A)	TE40 – TE80
Other tools	Blow out pump ( $h_{ef} \leq 10 \cdot d$ )	-
	Compressed air gun <sup>a)</sup> Set of cleaning brushes <sup>b)</sup> , dispenser, piston plug	

a) Compressed air gun with extension hose for all drill holes deeper than 250 mm (for φ 8 to φ 12) or deeper than  $20 \cdot \phi$  (for φ > 12 mm).

b) Automatic brushing with round brush for all drill holes deeper than 250 mm (for φ 8 to φ 12) or deeper than  $20 \cdot \phi$  (for φ > 12 mm).

### Minimum concrete cover $c_{min}$ of the post-installed rebar

Drilling method	Bar diameter [mm]	Minimum concrete cover $c_{min}$ [mm]	
		Without drilling aid	With drilling aid
Hammer drilling (HD) and (HDB)	$\phi < 25$	$30 + 0,06 \cdot l_v \geq 2 \cdot \phi$	$30 + 0,02 \cdot l_v \geq 2 \cdot \phi$
	$\phi \geq 25$	$40 + 0,06 \cdot l_v \geq 2 \cdot \phi$	$40 + 0,02 \cdot l_v \geq 2 \cdot \phi$
Compressed air drilling (CA)	$\phi < 25$	$50 + 0,08 \cdot l_v$	$50 + 0,02 \cdot l_v$
	$\phi \geq 25$	$60 + 0,08 \cdot l_v \geq 2 \cdot \phi$	$60 + 0,02 \cdot l_v \geq 2 \cdot \phi$
Diamond coring with roughening with Hilti Roughening tool TE-YRT (RT)	$\phi < 25$	$30 + 0,06 \cdot l_v \geq 2 \cdot \phi$	$30 + 0,02 \cdot l_v \geq 2 \cdot \phi$
	$\phi \geq 25$	$40 + 0,06 \cdot l_v \geq 2 \cdot \phi$	$40 + 0,02 \cdot l_v \geq 2 \cdot \phi$

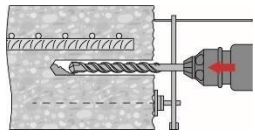



### Drilling and cleaning diameters

Rebar [mm]	Drilling				Cleaning	
	Hammer drill (HD)	Hollow Drill Bit (HDB) <sup>b)</sup>	Compressed air drill (CA)	Diamond coring with roughening tool (RT)	Brush HIT-RB	Air nozzle HIT-RB
	$d_0$ [mm]				size [mm]	
φ8	12 / 10 <sup>a)</sup>	12	-	-	12 / 10 <sup>a)</sup>	12 / 10 <sup>a)</sup>
φ10	14 / 12 <sup>a)</sup>	14 / 12 <sup>a)</sup>	-	-	14 / 12 <sup>a)</sup>	14 / 12 <sup>a)</sup>
φ12	16 / 14 <sup>a)</sup>	16 / 14 <sup>a)</sup>	-	-	16 / 14 <sup>a)</sup>	16 / 14 <sup>a)</sup>
	-	-	17	-	18	16
φ14	18	18	17	18	18	18
φ16	20	20	-	-	20	20
	-	-	20	20	22	20
φ18	22	22	22	22	22	22
φ20	25	25	-	-	25	25
	-	-	26	25	28	25
φ22	28	28	28	28	28	28
φ24	32	32	32	32	32	32
φ25	32	32	32	32	32	
φ26	35	-	35	35	35	
φ28	35	-	35	35	35	
φ30	-	-	35	-	35	
	37	-	-	-	37	
φ32	40	-	40	-	40	

a) Maximum installation length  $l=250$  mm.

**Associated components for the use of Hilti Roughening tool TE-YRT**

Diamond coring		Roughening tool TE-YRT	Wear gauge RTG...
			
d <sub>0</sub> [mm]		d <sub>0</sub> [mm]	size
Nominal	measured		
18	17,9 to 18,2	18	18
20	19,9 to 20,2	20	20
22	21,9 to 22,2	22	22
25	24,9 to 25,2	25	25
28	27,9 to 28,2	28	28
30	29,9 to 30,2	30	30
32	31,9 to 32,2	32	32
35	34,9 to 35,2	35	35

**Installation parameters for use of the Hilti Roughening tool TE-YRT**

h <sub>ef</sub> [mm]	Minimum roughening time t <sub>roughen</sub> [sec] (t <sub>roughen</sub> [sec] = h <sub>ef</sub> [mm] / 10)	Minimum blowing time t <sub>blowing</sub> [sec] (t <sub>blowing</sub> [sec] = t <sub>roughen</sub> [sec] + 20)
0 to 100	10	30
101 to 200	20	40
201 to 300	30	50
301 to 400	40	60
401 to 500	50	70
501 to 600	60	80

**Dispensers and corresponding maximum embedment depth  $l_{v,max}$** 

Rebar	Dispenser	
	HDM 330, HDM 500, HDE 500	HDE 500
	Concrete temp. $\geq -10^{\circ}\text{C}$	Concrete temp. $\geq 0^{\circ}\text{C}$
	$l_{v,max}$ [mm]	$l_{v,max}$ [mm]
$\phi 8 - \phi 32$	700	1000

## Setting instructions

\*For detailed information on installation see instruction for use given with the package of the product.



### Safety regulations.

Review the Material Safety Data Sheet (MSDS) before use for proper and safe handling! Wear well-fitting protective goggles and protective gloves when working with Hilti HIT-HY 200.

## Drilling

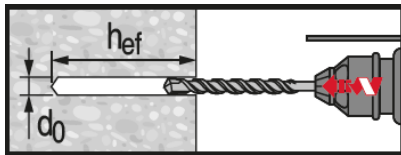

**Hammer drilled hole (HD)**

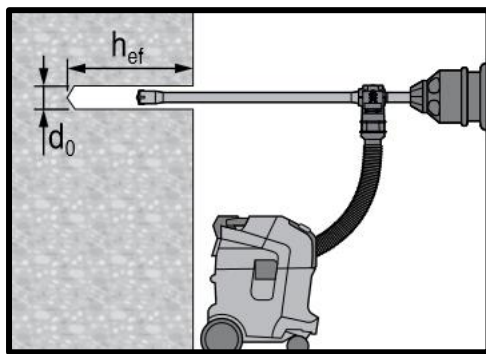

**Hammer drilled hole with Hollow Drilled Bit (HDB)**

No cleaning required

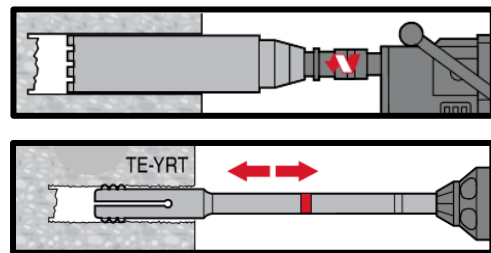

**Diamond Drilling + Roughening Tool (DD+RT)**

## Cleaning

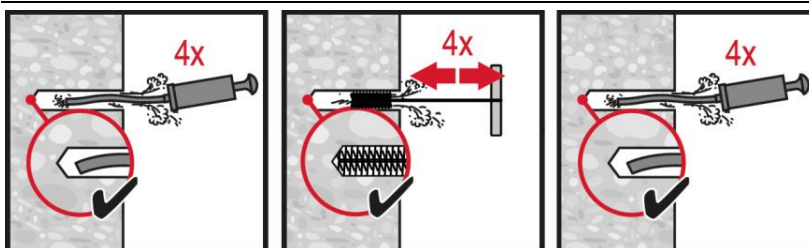

### Hammer drilling:

#### Manual cleaning (MC)

for drill diameters  $d_0 \leq 20$  mm and drill hole depth  $h_0 \leq 10 \cdot d$ .

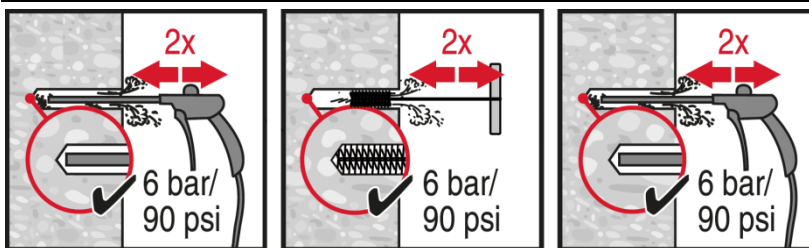

### Hammer drilling:

#### Compressed air cleaning (CAC)

for all drill hole diameters  $d_0$  and drill hole depths  $h_0 \leq 20 \cdot d$ .

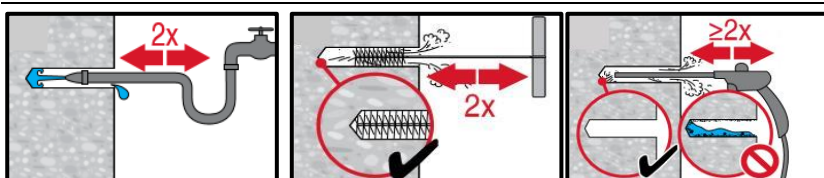

### Diamond cored holes with Hilti roughening tool:

For all drill hole diameters  $d_0$  and drill hole depths  $h_0$ .

**Injection system preparation**

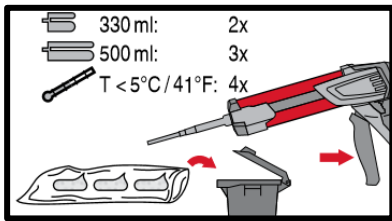
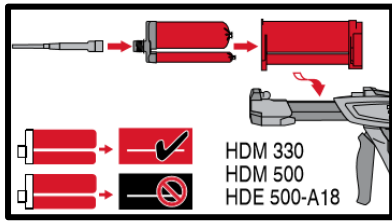

**Injection system preparation.**

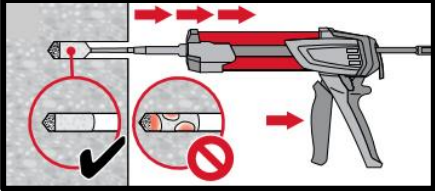
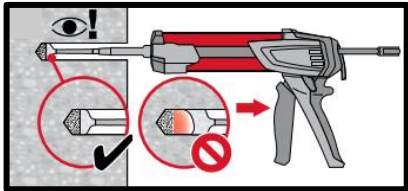

**Injection method for drill hole depth**  
 $h_{ef} \leq 250 \text{ mm.}$

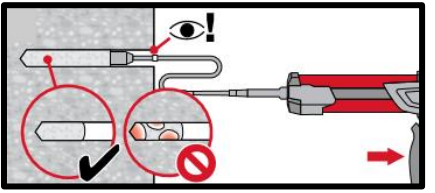
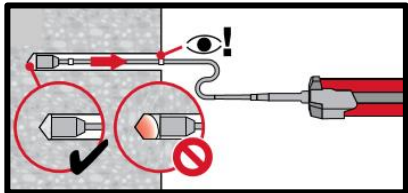

**Injection method for drill hole depth**  
 $h_{ef} > 250 \text{ mm.}$

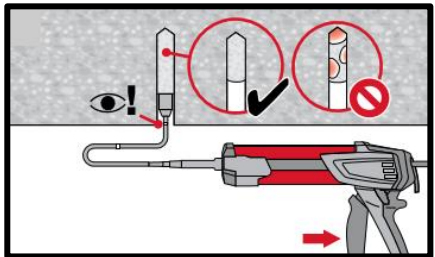
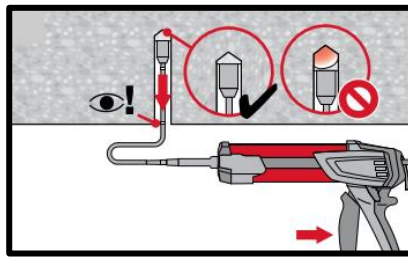

**Injection method for overhead application.**

### Setting the element

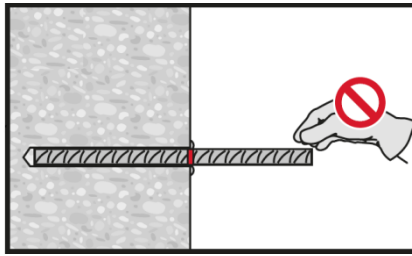
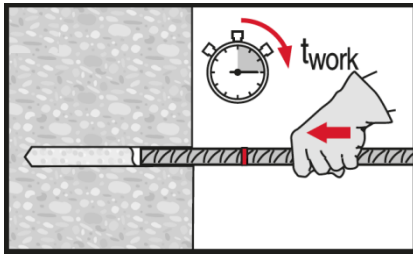

**Setting element**, observe working time "t<sub>work</sub>".

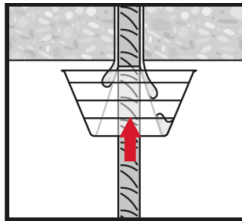
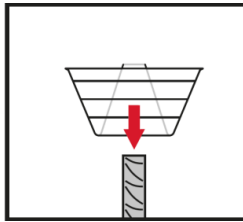
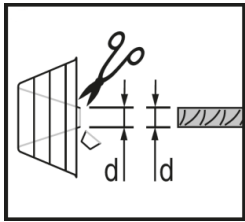

**Setting element** for overhead applications, observe working time "t<sub>work</sub>".

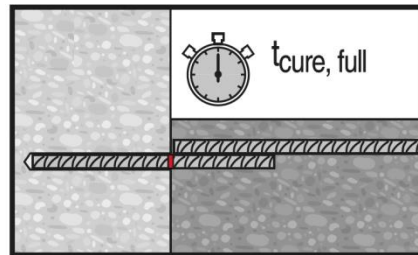
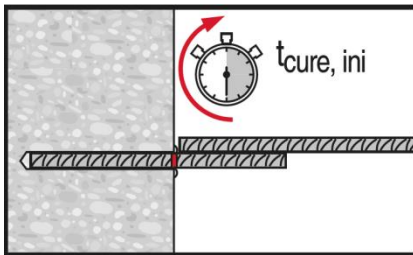
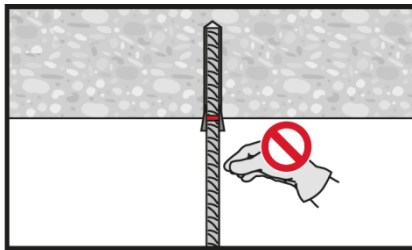
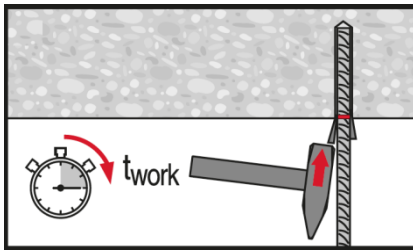

Apply full load only after curing time "t<sub>cure</sub>".