

Approval body for construction products  
and types of construction

Bautechnisches Prüfamt

An institution established by the Federal and  
Laender Governments



## European Technical Assessment

**ETA-19/0601**  
**of 2 June 2023**

English translation prepared by DIBt - Original version in German language

### General Part

Technical Assessment Body issuing the  
European Technical Assessment:

Deutsches Institut für Bautechnik

Trade name of the construction product

Injection System Hilti HIT-HY 200-A V3 and  
HIT-HY 200-R V3

Product family  
to which the construction product belongs

Bonded fastener and bonded expansion fasteners for use  
in concrete

Manufacturer

Hilti Aktiengesellschaft  
Feldkircherstrasse 100  
9494 SCHAAN  
FÜRSTENTUM LIECHTENSTEIN

Manufacturing plant

Hilti Plants

This European Technical Assessment  
contains

53 pages including 3 annexes which form an integral part  
of this assessment

This European Technical Assessment is  
issued in accordance with Regulation (EU)  
No 305/2011, on the basis of

EAD 330499-02-0601 Edition 04/2023

This version replaces

ETA-19/0601 issued on 2 December 2021

The European Technical Assessment is issued by the Technical Assessment Body in its official language. Translations of this European Technical Assessment in other languages shall fully correspond to the original issued document and shall be identified as such.

Communication of this European Technical Assessment, including transmission by electronic means, shall be in full. However, partial reproduction may only be made with the written consent of the issuing Technical Assessment Body. Any partial reproduction shall be identified as such.

This European Technical Assessment may be withdrawn by the issuing Technical Assessment Body, in particular pursuant to information by the Commission in accordance with Article 25(3) of Regulation (EU) No 305/2011.

## Specific Part

### 1 Technical description of the product

The injection system Hilti HIT-HY 200-A V3 and HIT-HY 200-R V3 is a bonded fastener consisting of a foil pack with injection mortar Hilti HIT-HY 200-A V3 or HIT-HY 200-R V3 and a steel element according to Annex A.

The steel element is placed into a drilled hole filled with injection mortar and is anchored via the bond between metal part, injection mortar and concrete.

The product description is given in Annex A.

### 2 Specification of the intended use in accordance with the applicable European Assessment Document

The performances given in Section 3 are only valid if the fastener is used in compliance with the specifications and conditions given in Annex B.

The verifications and assessment methods on which this European Technical Assessment is based lead to the assumption of a working life of the anchor of at least 50 and / or 100 years. The indications given on the working life cannot be interpreted as a guarantee given by the producer, but are to be regarded only as a means for choosing the right products in relation to the expected economically reasonable working life of the works.

### 3 Performance of the product and references to the methods used for its assessment

#### 3.1 Mechanical resistance and stability (BWR 1)

Essential characteristic	Performance
Characteristic resistance to tension load (static and quasi-static loading)	See Annex C1 to C3, C5 to C6, C8 to C10, C12 to C14, B3 to B7
Characteristic resistance to shear load (static and quasi-static loading)	See Annex C4, C7, C11, C15
Displacements under short-term and long-term loading	See Annex C16 to C19
Characteristic resistance and displacements for seismic performance categories C1 and C2	See Annex C20 to C24

#### 3.2 Safety in case of fire (BWR 2)

Essential characteristic	Performance
Reaction to fire	class A1
Resistance to fire	See Annex C25 to C27

#### 3.3 Hygiene, health and the environment (BWR 3)

Essential characteristic	Performance
Content, emission and/or release of dangerous substances	No performance assessed

English translation prepared by DIBt

**4 Assessment and verification of constancy of performance (AVCP) system applied, with reference to its legal base**

In accordance with the European Assessment Document EAD 330499-02-0601 the applicable European legal act is: [96/582/EC].

The system to be applied is: 1

**5 Technical details necessary for the implementation of the AVCP system, as provided for in the applicable European Assessment Document**

Technical details necessary for the implementation of the AVCP system are laid down in the control plan deposited at Deutsches Institut für Bautechnik.

The following standards and documents are referred to in this European Technical Assessment:

- EN 1992-1-1:2004 + AC:2010 Eurocode 2: Design of concrete structures - Part 1-1: General rules and rules for buildings
- EN 1992-1-2:2004 + AC:2008 Eurocode 2: Design of concrete structures - Part 1-2: General rules - Structural fire design
- EN 1992-4:2018 Eurocode 2: Design of concrete structures - Part 4: Design of fastenings for use in concrete
- EN 1993-1-4:2006 + A1:2015 Eurocode 3: Design of steel structures - Part 1-4: General rules - Supplementary rules for stainless steels
- EN 1998-1:2004 + AC:2009 Eurocode 8: Design of structures for earthquake resistance - Part 1: General rules, seismic actions and rules for buildings
- EN 10088-1:2014 Stainless steels - Part 1: List of stainless steels
- EN 206:2013 + A1:2016 Concrete - Specification, performance, production and conformity
- EN 10204:2004 Metallic products – Types of inspection documents
- DIN 488-1:2009-08 Reinforcing steels – Part 1: Grades, properties, marking
- EOTA TR 055 Design of fastenings based on EAD 330232-00-0601, EAD 330499-00-0601 and EAD 330747-00-0601, Februar 2018
- EOTA TR 082 Design of bonded fasteners in concrete under fire conditions, August 2022

Issued in Berlin on 2 June 2023 by Deutsches Institut für Bautechnik

Dipl.-Ing. Beatrix Wittstock  
Head of Section

*beglaubigt:*  
Stiller

## Installed condition

**Figure A1:**

Threaded rod, HAS..., HAS-U..., HIT-V-... and AM 8.8

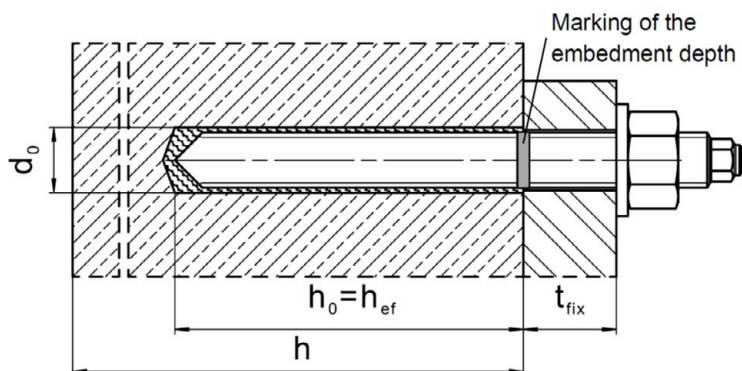

**Figure A2:**

Threaded rod, HAS..., HAS-U..., HIT-V-... and AM 8.8 with Hilti Filling Set

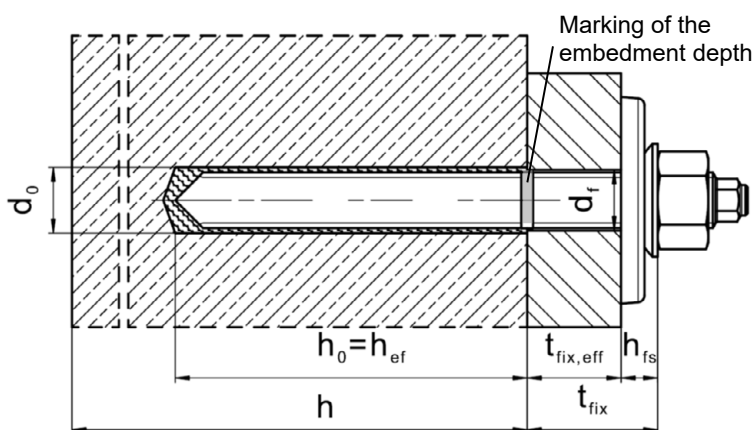

**Figure A3:**

Internally threaded sleeve HIS-(R)N

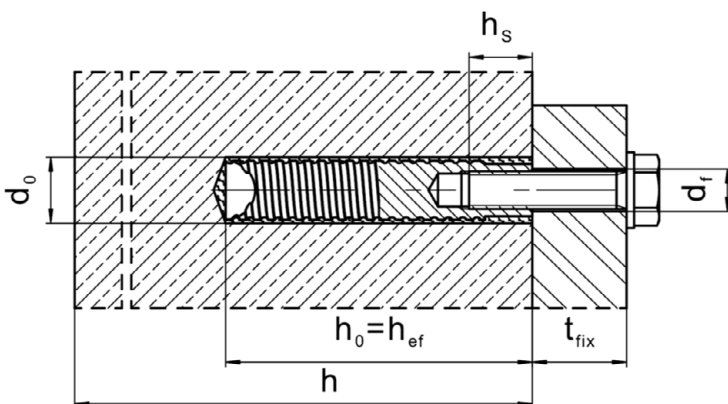

Injection System Hilti HIT-HY 200-A V3 and HIT-HY 200-R V3

Product description  
Installed condition

Annex A1

## Installed condition

**Figure A4:**  
**Reinforcing bar**

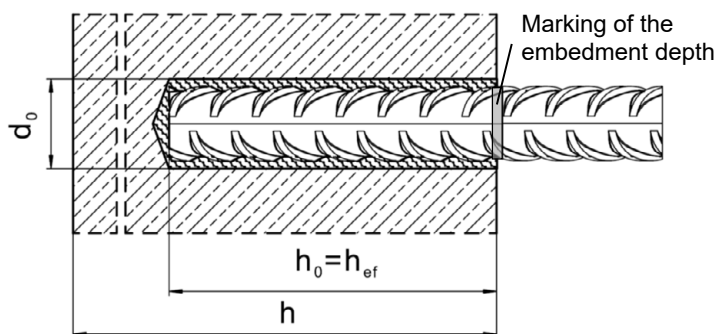

**Injection System Hilti HIT-HY 200-A V3 and HIT-HY 200-R V3**

**Product description**  
Installed condition

**Annex A2**

### Product description: Injection mortar

**Injection mortar Hilti HIT-HY 200-A V3 and HIT-HY 200-R V3: hybrid system with aggregate 330 ml and 500 ml**

Marking:  
HILTI HIT  
HY 200-A V3  
Production time and production line  
Expiry date mm/yyyy



Product name: "Hilti HIT-HY 200-A V3"

Marking:  
HILTI HIT  
HY 200-R V3  
Production time and  
production line  
Expiry date mm/yyyy



Product name: "Hilti HIT-HY 200-R V3"

### Static mixer Hilti HIT-RE-M



**Injection System Hilti HIT-HY 200-A V3 and HIT-HY 200-R V3**

**Product description**  
Injection mortar / Static mixer

**Annex A3**

**Steel elements**

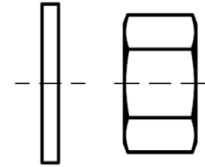
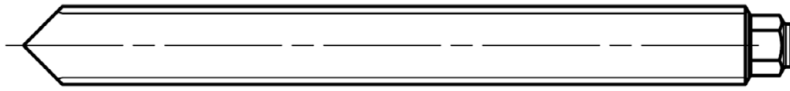

**HAS-U-...: M8 to M30**

washer nut

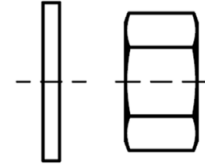
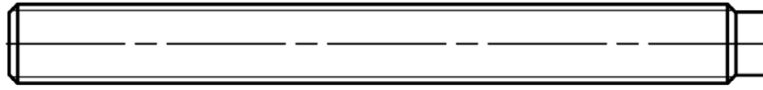

**HIT-V-...: M8 to M30**

washer nut

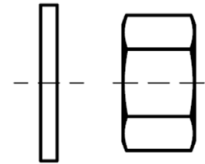
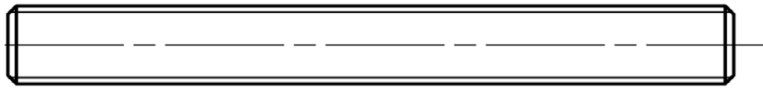

**HAS...: M8 to M30**

**Threaded rod: M8 to M30**

**Hilti AM 8.8 meter rod electroplated zinc coated: M8 to M30, 1m to 3m**

**Hilti AM HDG 8.8 meter rod hot dip galvanized: M8 to M30, 1m to 3m**

washer nut

Commercial standard threaded rod:

- Materials and mechanical properties according to Table A1.
- Inspection certificate 3.1 according to EN 10204. The document shall be stored.
- Marking of embedment depth.

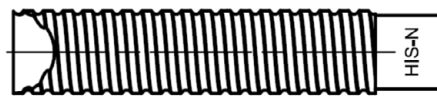

**Internally threaded sleeve: HIS-(R)N M8 to M20**

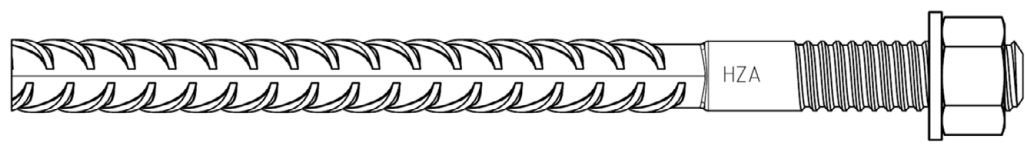

**Hilti Tension Anchor: HZA M12 to M27 and HZA-R M12 to M24**



**Reinforcing bar (rebar):  $\phi$  8 to  $\phi$  32**

- Materials and mechanical properties according to Table A1
- Dimensions according to Annex B7

**Injection System Hilti HIT-HY 200-A V3 and HIT-HY 200-R V3**

**Product description**  
Steel elements

**Annex A4**

**Hilti Filling Set to fill the annular gap between steel element and fixture**

Sealing washer

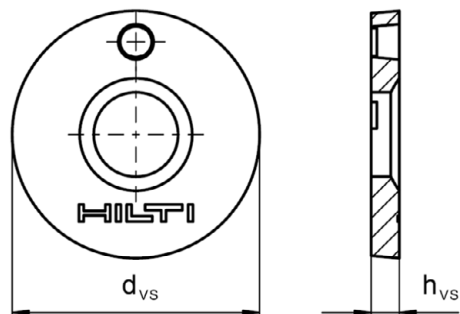

Spherical washer

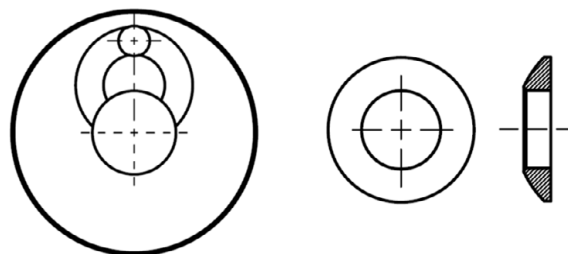

Hilti Filling Set		M10	M12	M16	M20	M24
Diameter of sealing washer	$d_{vs}$ [mm]	42	44	52	60	70
Thickness of sealing washer	$h_{vs}$ [mm]	5	5	6	6	6
Thickness of Hilti Filling Set	$h_{fs}$ [mm]	9	10	11	13	15

**Injection System Hilti HIT-HY 200-A V3 and HIT-HY 200-R V3**

**Product description**  
Hilti Filling Set

**Annex A5**

**Table A1: Materials**

Designation	Material
Reinforcing bars (rebars)	
Rebar EN 1992-1-1, Annex C	Bars and de-coiled rods class B or C with $f_{yk}$ and $k$ according to NDP or NCI of EN 1992-1-1/NA $f_{uk} = f_{tk} = k \cdot f_{yk}$
<b>Steel elements made of zinc coated steel</b>	
HAS 5.8 (HDG), HAS-U 5.8 (HDG), HIT-V 5.8(F), Threaded rod 5.8	Strength class 5.8, $f_{uk} = 500 \text{ N/mm}^2$ , $f_{yk} = 400 \text{ N/mm}^2$ , Elongation at fracture ( $l_0=5d$ ) > 8% ductile Electroplated zinc coated $\geq 5 \mu\text{m}$ , (F) or (HDG) hot dip galvanized $\geq 50 \mu\text{m}$
Threaded rod 6.8	Strength class 6.8, $f_{uk} = 600 \text{ N/mm}^2$ , $f_{yk} = 480 \text{ N/mm}^2$ , Elongation at fracture ( $l_0=5d$ ) > 8% ductile Electroplated zinc coated $\geq 5 \mu\text{m}$ or hot dip galvanized $\geq 50 \mu\text{m}$
HAS 8.8 (HDG), HAS-U 8.8 (HDG), HIT-V 8.8 (F), Threaded rod 8.8	Strength class 8.8, $f_{uk} = 800 \text{ N/mm}^2$ , $f_{yk} = 640 \text{ N/mm}^2$ , Elongation at fracture ( $l_0=5d$ ) > 12% ductile Electroplated zinc coated $\geq 5 \mu\text{m}$ , (F) or (HDG) hot dip galvanized $\geq 50 \mu\text{m}$
Hilti Meter rod AM 8.8 (HDG)	Strength class 8.8, $f_{uk} = 800 \text{ N/mm}^2$ , $f_{yk} = 640 \text{ N/mm}^2$ Elongation at fracture ( $l_0 = 5d$ ) > 12% ductile, Electroplated zinc coated $\geq 5 \mu\text{m}$ , (F) hot dip galvanized $\geq 50 \mu\text{m}$
Hilti tension anchor HZA	Round steel with threaded part: electroplated zinc coated $\geq 5 \mu\text{m}$ Rebar: Bars class B according to NDP or NCI of EN 1992-1-1/NA
Internally threaded sleeve HIS-N	Electroplated zinc coated $\geq 5 \mu\text{m}$
Washer	Electroplated zinc coated $\geq 5 \mu\text{m}$ , hot dip galvanized $\geq 50 \mu\text{m}$
Nut	Strength class of nut adapted to strength class of threaded rod Electroplated zinc coated $\geq 5 \mu\text{m}$ , (F) hot dip galvanized $\geq 50 \mu\text{m}$
Hilti Filling Set (F)	Filling washer: Electroplated zinc coated $\geq 5 \mu\text{m}$ , (F) hot dip galvanized $\geq 50 \mu\text{m}$ Spherical washer: Electroplated zinc coated $\geq 5 \mu\text{m}$ , (F) hot dip galvanized $\geq 50 \mu\text{m}$ Lock nut: Electroplated zinc coated $\geq 5 \mu\text{m}$ , (F) Electroplated zinc-nickel coated $\geq 6 \mu\text{m}$

**Injection System Hilti HIT-HY 200-A V3 and HIT-HY 200-R V3**

**Product description**  
Materials

**Annex A6**

**Table A1: continued**

<b>Steel elements made of stainless steel corrosion resistance class (CRC) II according EN 1993-1-4</b>	
Threaded rod	For $\leq$ M24: strength class 70, $f_{uk} = 700$ N/mm <sup>2</sup> , $f_{yk} = 450$ N/mm <sup>2</sup> ; For $>$ M24: strength class 50, $f_{uk} = 500$ N/mm <sup>2</sup> , $f_{yk} = 210$ N/mm <sup>2</sup> ; Elongation at fracture ( $l_0=5d$ ) $>$ 12% ductile Stainless steel 1.4301, 1.4307, 1.4311, 1.4541, 1.4306, 1.4567 EN 10088-1
Washer	Stainless steel 1.4301, 1.4307, 1.4311, 1.4541, 1.4306, 1.4567 EN 10088-1
Nut	For $\leq$ M24: strength class 70, $f_{uk} = 700$ N/mm <sup>2</sup> , $f_{yk} = 450$ N/mm <sup>2</sup> ; For $>$ M24: strength class 50, $f_{uk} = 500$ N/mm <sup>2</sup> , $f_{yk} = 210$ N/mm <sup>2</sup> ; Stainless steel 1.4301, 1.4307, 1.4311, 1.4541, 1.4306, 1.4567 EN 10088-1
<b>Steel elements made of stainless steel corrosion resistance class (CRC) III according EN 1993-1-4</b>	
HAS A4, HAS-U A4, HIT-V-R	For $\leq$ M24: strength class 70, $f_{uk} = 700$ N/mm <sup>2</sup> , $f_{yk} = 450$ N/mm <sup>2</sup> ; For $>$ M24: strength class 50, $f_{uk} = 500$ N/mm <sup>2</sup> , $f_{yk} = 210$ N/mm <sup>2</sup> ; Elongation at fracture ( $l_0=5d$ ) $>$ 12% ductile
Threaded rod	For $\leq$ M24: strength class 70, $f_{uk} = 700$ N/mm <sup>2</sup> , $f_{yk} = 450$ N/mm <sup>2</sup> ; For $>$ M24: strength class 50, $f_{uk} = 500$ N/mm <sup>2</sup> , $f_{yk} = 210$ N/mm <sup>2</sup> ; Elongation at fracture ( $l_0=5d$ ) $>$ 12% ductile Stainless steel 1.4401, 1.4404, 1.4578, 1.4571, 1.4439, 1.4362 EN 10088-1
Hilti tension anchor HZA-R	Round steel with threaded part: Stainless steel 1.4404, 1.4362, 1.4571 EN 10088-1 Rebar: Bars class B according to NDP or NCI of EN 1992-1-1/NA
Internally threaded sleeve HIS-RN	Stainless steel 1.4401, 1.4571 EN 10088-1
Washer	Stainless steel 1.4401, 1.4404, 1.4578, 1.4571, 1.4439, 1.4362 EN 10088-1
Nut	For $\leq$ M24: strength class 70, $f_{uk} = 700$ N/mm <sup>2</sup> , $f_{yk} = 450$ N/mm <sup>2</sup> ; For $>$ M24: strength class 50, $f_{uk} = 500$ N/mm <sup>2</sup> , $f_{yk} = 210$ N/mm <sup>2</sup> ; Stainless steel 1.4401, 1.4404, 1.4578, 1.4571, 1.4439, 1.4362 EN 10088-1
Hilti Filling Set A4	Filling washer: Stainless steel according to EN 10088-1 Spherical washer: Stainless steel according to EN 10088-1 Lock nut: Stainless steel according to EN 10088-1
<b>Steel elements made of high corrosion resistant steel corrosion resistance class (CRC) V according EN 1993-1-4</b>	
HAS-U HCR, HIT-V-HCR	For $\leq$ M20: $f_{uk} = 800$ N/mm <sup>2</sup> , $f_{yk} = 640$ N/mm <sup>2</sup> ; For $>$ M20: $f_{uk} = 700$ N/mm <sup>2</sup> , $f_{yk} = 400$ N/mm <sup>2</sup> ; Elongation at fracture ( $l_0=5d$ ) $>$ 12% ductile
Threaded rod	For $\leq$ M20: $f_{uk} = 800$ N/mm <sup>2</sup> , $f_{yk} = 640$ N/mm <sup>2</sup> ; For $>$ M20: $f_{uk} = 700$ N/mm <sup>2</sup> , $f_{yk} = 400$ N/mm <sup>2</sup> ; Elongation at fracture ( $l_0=5d$ ) $>$ 12% ductile High corrosion resistant steel 1.4529, 1.4565 EN 10088-1
Washer	High corrosion resistant steel 1.4529, 1.4565 EN 10088-1
Nut	For $\leq$ M20: $f_{uk} = 800$ N/mm <sup>2</sup> , $f_{yk} = 640$ N/mm <sup>2</sup> ; For $>$ M20: $f_{uk} = 700$ N/mm <sup>2</sup> , $f_{yk} = 400$ N/mm <sup>2</sup> ; High corrosion resistant steel 1.4529, 1.4565 EN 10088-1

**Injection System Hilti HIT-HY 200-A V3 and HIT-HY 200-R V3**

**Product description**  
Materials

**Annex A7**

## Specifications of intended use

### Anchorage subject to:

- Static and quasi static loading.
- Seismic performance category C1 and C2 (see Table B1).
- Fire exposure: threaded rod size M8 to M30

### Base material:

- Compacted reinforced or unreinforced normal weight concrete without fibres according to EN 206.
- Strength classes C20/25 to C50/60 according to EN 206.
- Cracked and uncracked concrete.

### Temperature in the base material:

- **at installation**

-10 °C to +40 °C for the standard variation of temperature after installation

- **in-service**

Temperature range I: -40 °C to +40 °C

(max. long term temperature +24 °C and max. short term temperature +40 °C)

Temperature range II: -40 °C to +80 °C

(max. long term temperature +50 °C and max. short term temperature +80 °C)

Temperature range III: -40 °C to +120 °C









(max. long term temperature +72 °C and max. short term temperature +120 °C)

**Injection System Hilti HIT-HY 200-A V3 and HIT-HY 200-R V3**

**Intended Use**  
Specifications

**Annex B1**

**Table B1: Specifications of intended use**

Steel elements	HIT-HY 200-A V3 and HIT-HY 200-R V3 with ...			
	Threaded rods according to Annex A 	Rebar 	HZA(-R) 	HIS-(R)N 
Hammer drilling with hollow drill bit TE-CD or TE-YD 	✓	✓	✓	✓
Hammer drilling 	✓	✓	✓	✓
Diamond drilling with roughening tool TE-YRT  	✓	✓	✓	✓
Installation in waterfilled hole	✓	✓	✓	- <sup>1)</sup>
Static and quasi static loading in uncracked concrete	M8 to M30	φ 8 to φ 32	M12 to M27	M8 to M20
Static and quasi static loading in cracked concrete	M8 to M30	φ 10 to φ 32	M12 to M27	M8 to M20
Seismic performance category C1	M10 to M30	φ 10 to φ 32	M12 to M27	- <sup>1)</sup>
Seismic performance category C2	M12 to M24, HAS (8.8, -8.8 HDG, A4) HAS-U (8.8, 8.8 HDG, A4, HCR) HIT-V- (8.8, 8.8 F, R, HCR), AM (8.8, 8.8 HDG) Threaded rod (electroplated zinc coated 8.8 and CRC III, V, Table A1)	- <sup>1)</sup>	- <sup>1)</sup>	- <sup>1)</sup>
Working life 50 or 100 years	50 and 100	50 and 100	50 and 100	50
Exposure under fire	Elements made of zinc coated steel and stainless steel CRC III and CRC V see Table A1	- <sup>1)</sup>	- <sup>1)</sup>	- <sup>1)</sup>

<sup>1)</sup> No performance assessed.

**Injection System Hilti HIT-HY 200-A V3 and HIT-HY 200-R V3**

**Intended Use Specifications**

**Annex B2**

**Use conditions (Environmental conditions):**

- Structures subject to dry internal conditions (all materials).
- For all other conditions according EN 1993-1-4 corresponding to corrosion resistance classes Table A1 (stainless steels).

**Design:**

- Fastenings are designed under the responsibility of an engineer experienced in fastenings and concrete work.
- Verifiable calculation notes and drawings are prepared taking account of the loads to be fastened. The position of the fastener is indicated on the design drawings (e. g. position of the fastener relative to reinforcement or to supports, etc.).
- The anchorages are designed in accordance with: EN 1992-4 and EOTA Technical Report TR 055.
- Design under fire exposure in accordance with: EOTA Technical Report TR 082.

**Installation:**

- Concrete condition I1: Installation in dry or wet (water saturated) concrete and use in service in dry or wet concrete for all drilling techniques
- Concrete condition I2: Installation in water-filled drill holes (not sea water) and use in service in dry or wet concrete for hammer drilling and hammer drilling with Hilti hollow drill bit TE-CD, TE-YD
- Drilling technique:
  - Hammer drilling,
  - Hammer drilling with Hilti hollow drill bit TE-CD, TE-YD,
  - Diamond coring with roughening with Hilti roughening tool TE-YRT.
- Installation direction D3: downward, horizontal and upward (e.g. overhead) installation admissible for all elements.
- Fastener installation carried out by appropriately qualified personnel and under the supervision of the person responsible for technical matters of the site.

<b>Injection System Hilti HIT-HY 200-A V3 and HIT-HY 200-R V3</b>	<b>Annex B3</b>
<b>Intended Use Specifications</b>	

**Table B2: Installation parameters of threaded rods according to Annex A**

Threaded rods according to Annex A			M8	M10	M12	M16	M20	M24	M27	M30
Diameter of element	d	[mm]	8	10	12	16	20	24	27	30
Nominal diameter of drill bit	d <sub>0</sub>	[mm]	10	12	14	18	22	28	30	35
Effective embedment depth and drill hole depth	h <sub>ef</sub> = h <sub>0</sub>	[mm]	60 to 160	60 to 200	70 to 240	80 to 320	90 to 400	96 to 480	108 to 540	120 to 600
Maximum diameter of clearance hole in the fixture	d <sub>f</sub>	[mm]	9	12	14	18	22	26	30	33
Thickness of Hilti Filling Set	h <sub>fs</sub>	[mm]	-	9	10	11	13	15	-	-
Effective fixture thickness with Hilti Filling Set	t <sub>fix,eff</sub>	[mm]	$t_{fix,eff} = t_{fix} - h_{fs}$							
Minimum thickness of concrete member	h <sub>min</sub>	[mm]	$h_{ef} + 30$ ≥ 100 mm			$h_{ef} + 2 \cdot d_0$				
Maximum installation torque	max T <sub>inst</sub>	[Nm]	10	20	40	80	150	200	270	300
Minimum spacing	s <sub>min</sub>	[mm]	40	50	60	75	90	115	120	140
Minimum edge distance	c <sub>min</sub>	[mm]	40	45	45	50	55	60	75	80

**HAS-U...**

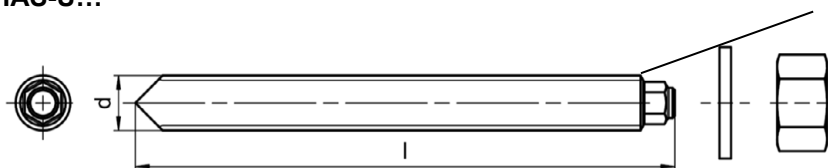

**Marking:**

Steel grade number and length identification letter: e.g. 8L

**HAS..., HIT-V-...**

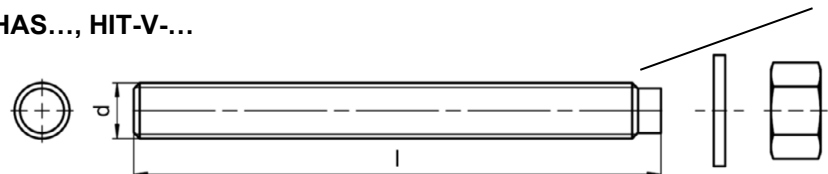

**HIT-V Marking:**

5.8 - l = HIT-V-5.8 M...x l  
 5.8F - l = HIT-V-5.8F M...x l  
 8.8 - l = HIT-V-8.8 M...x l  
 8.8F - l = HIT-V-8.8F M...x l  
 R - l = HIT-V-R M...x l  
 HCR - l = HIT-V-HCR M...x l

**Hilti meter rod AM (HDG) 8.8**



**HAS Color code marking:**

5.8 = RAL 5010 (blue)  
 8.8 = RAL 1023 (yellow)  
 A4 = RAL 3000 (red)

**Injection System Hilti HIT-HY 200-A V3 and HIT-HY 200-R V3**

**Intended Use**

Installation parameters of threaded rod, HAS..., HAS-U..., HIT-V-... and AM 8.8

**Annex B4**

**Table B3: Installation parameters of internally threaded sleeve HIS-(R)N**

Internally threaded sleeve HIS-(R)N...			M8	M10	M12	M16	M20
Outer diameter of sleeve	d	[mm]	12,5	16,5	20,5	25,4	27,6
Nominal diameter of drill bit	d <sub>0</sub>	[mm]	14	18	22	28	32
Effective embedment depth and drill hole depth	h <sub>ef</sub> = h <sub>0</sub>	[mm]	90	110	125	170	205
Maximum diameter of clearance hole in the fixture	d <sub>f</sub>	[mm]	9	12	14	18	22
Minimum thickness of concrete member	h <sub>min</sub>	[mm]	120	150	170	230	270
Maximum installation torque	max T <sub>inst</sub>	[Nm]	10	20	40	80	150
Thread engagement length min-max	h <sub>s</sub>	[mm]	8-20	10-25	12-30	16-40	20-50
Minimum spacing	s <sub>min</sub>	[mm]	60	75	90	115	130
Minimum edge distance	c <sub>min</sub>	[mm]	40	45	55	65	90

**Internally threaded sleeve HIS-(R)N...**

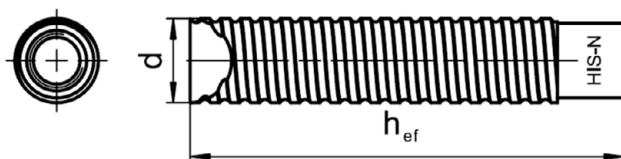

**Marking:**

Identifying mark - HILTI and embossing "HIS-N" (for C-steel)  
embossing "HIS-RN" (for stainless steel)

**Injection System Hilti HIT-HY 200-A V3 and HIT-HY 200-R V3**

**Intended Use**

Installation parameters of internally threaded sleeve HIS-(R)N

**Annex B5**

**Table B4: Installation parameters of Hilti tension anchor HZA and HZA-R**

Hilti tension anchor HZA		M12	M16	M20	M24	M27
Hilti tension anchor HZA-R		M12	M16	M20	M24	-
Rebar diameter	$\phi$ [mm]	12	16	20	25	28
Nominal embedment depth and drill hole depth HZA	$h_{nom} = h_0$ [mm]	90 to 240	100 to 320	110 to 400	120 to 500	140 to 560
Nominal embedment depth and drill hole depth HZA-R	$h_{nom} = h_0$ [mm]	170 to 240	180 to 320	190 to 400	200 to 500	-
Effective embedment depth ( $h_{ef} = h_{nom} - l_e$ ) HZA	$h_{ef}$ [mm]	$h_{nom} - 20$				
Effective embedment depth ( $h_{ef} = h_{nom} - l_e$ ) HZA-R	$h_{ef}$ [mm]	$h_{nom} - 100$				
Length of smooth shaft HZA	$l_e$ [mm]	20				
Length of smooth shaft HZA-R	$l_e$ [mm]	100				
Nominal diameter of drill bit	$d_0$ [mm]	16	20	25	32	35
Maximum diameter of clearance hole in the fixture	$d_f$ [mm]	14	18	22	26	30
Thickness of Hilti Filling Set	$h_{fs}$ [mm]	10	11	13	15	-
Effective fixture thickness with Hilti Filling Set	$t_{fix,eff}$ [mm]	$t_{fix,eff} = t_{fix} - h_{fs}$				
Maximum installation torque	$\max T_{inst}$ [Nm]	40	80	150	200	270
Minimum thickness of concrete member	$h_{min}$ [mm]	$h_{nom} + 2 \cdot d_0$				
Minimum spacing	$s_{min}$ [mm]	65	80	100	130	140
Minimum edge distance	$c_{min}$ [mm]	45	50	55	60	75

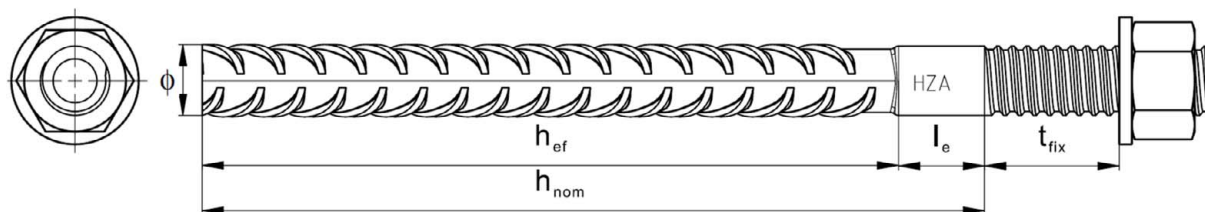

**Marking:**  
embossing "HZA(-R)" M .. /  $t_{fix}$

**Injection System Hilti HIT-HY 200-A V3 and HIT-HY 200-R V3**

**Intended Use**  
Installation parameters of Hilti tension anchor HZA and HZA-R

**Annex B6**

**Table B5: Installation parameters of reinforcing bar**

Reinforcing bar (rebar)	$\phi$ 8	$\phi$ 10	$\phi$ 12	$\phi$ 14	$\phi$ 16	$\phi$ 20	$\phi$ 25	$\phi$ 26	$\phi$ 28	$\phi$ 30	$\phi$ 32
Diameter $\phi$ [mm]	8	10	12	14	16	20	25	26	28	30	32
Effective embedment depth and drill hole depth $h_{ef} = h_0$ [mm]	60 to 160	60 to 200	70 to 240	75 to 280	80 to 320	90 to 400	100 to 500	104 to 520	112 to 560	120 to 600	128 to 640
Nominal diameter of drill bit $d_0$ [mm]	10 / 12 <sup>1)</sup>	12 / 14 <sup>1)</sup>	14 <sup>1)</sup> / 16 <sup>1)</sup>	18	20	25	32	32	35	37	40
Minimum thickness of concrete member $h_{min}$ [mm]	$h_{ef} + 30$ $\geq 100$ mm			$h_{ef} + 2 \cdot d_0$							
Minimum spacing $s_{min}$ [mm]	40	50	60	70	80	100	125	130	140	150	160
Minimum edge distance $c_{min}$ [mm]	40	45	45	50	50	65	70	75	75	80	80

<sup>1)</sup> Each of the two given values can be used.

**Reinforcing bar**

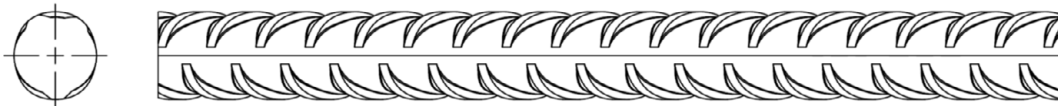

For rebar bolt

- Minimum value of related rib area  $f_{R,min}$  according to EN 1992-1-1
- Rib height of the bar  $h_{rib}$  shall be in the range  $0,05 \cdot \phi \leq h_{rib} \leq 0,07 \cdot \phi$   
( $\phi$ : Nominal diameter of the bar;  $h_{rib}$ : Rib height of the bar)

**Injection System Hilti HIT-HY 200-A V3 and HIT-HY 200-R V3**

**Intended Use**  
Installation parameters of reinforcing bar (rebar)

**Annex B7**

**Table B6: Maximum working time and minimum curing time**

Temperature in the base material T <sup>1)</sup>	HIT-HY 200-A V3		HIT-HY 200-R V3	
	Maximum working time $t_{work}$	Minimum curing time $t_{cure}$	Maximum working time $t_{work}$	Minimum curing time $t_{cure}$
-10 °C to -5 °C	1,5 hours	7 hours	3 hours	20 hours
> -5 °C to 0 °C	50 min	4 hours	1,5 hours	8 hours
> 0 °C to 5 °C	25 min	2 hours	45 min	4 hours
>5 °C to 10 °C	15 min	75 min	30 min	2,5 hours
>10 °C to 20 °C	7 min	45 min	15 min	1,5 hours
>20 °C to 30 °C	4 min	30 min	9 min	1 hours
>30 °C to 40 °C	3 min	30 min	6 min	1 hours









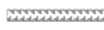

<sup>1)</sup> The minimum foil pack temperature is 0 °C.

**Injection System Hilti HIT-HY 200-A V3 and HIT-HY 200-R V3**

**Intended Use**  
Maximum working time and minimum curing time

**Annex B8**

**Table B7: Parameters of drilling, cleaning and setting tools**

Steel elements				Drill and clean				Installation	
Threaded rods (Annex A)	HIS-(R)N	Rebar	HZA(-R)	Hammer drilling		Diamond coring		Brush	Piston plug
					Hollow drill bit <sup>1)</sup>		Roughening tool		
Size	size	size	size	d <sub>0</sub> [mm]	d <sub>0</sub> [mm]	d <sub>0</sub> [mm]	d <sub>0</sub> [mm]	HIT-RB	HIT-SZ
									
M8	-	φ8	-	10	-	-	-	10	-
M10	-	φ8 / φ10	-	12	12	-	-	12	12
M12	M8	φ10 / φ12	-	14	14	-	-	14	14
-	-	φ12	M12	16	16	-	-	16	16
M16	M10	φ14	-	18	18	18	18	18	18
-	-	φ16	M16	20	20	20	20	20	20
M20	M12	-	-	22	22	22	22	22	22
-	-	φ20	M20	25	25	25	25	25	25
M24	M16	-	-	28	28	28	28	28	28
M27	-	-	-	30	-	30	30	30	30
-	M20	φ25 / φ26	M24	32	32	32	32	32	32
M30	-	φ28	M27	35	35	35	35	35	35
-	-	φ30	-	37	-	-	-	37	37
-	-	φ32	-	40	-	-	-	40	40

<sup>1)</sup> With vacuum cleaner Hilti VC 10/20/40 (automatic filter cleaning activated, eco mode off) or a vacuum cleaner providing equivalent cleaning performance in combination with the specified Hilti hollow drill bit TE-CD or TE-YD.

### Cleaning alternatives

#### Manual Cleaning (MC):

Hilti hand pump for blowing out drill holes with diameters  $d_0 \leq 20$  mm and drill hole depths  $h_0 \leq 10 \cdot d_0$ .



#### Compressed air cleaning (CAC):

Air nozzle with an orifice opening of minimum 3,5 mm in diameter.



#### Automatic Cleaning (AC):

Cleaning is performed during drilling with Hilti TE-CD and TE-YD drilling system including vacuum cleaner.





**Injection System Hilti HIT-HY 200-A V3 and HIT-HY 200-R V3**

#### Intended Use

Parameters of drilling, cleaning and setting tools  
Cleaning alternatives

**Annex B9**



**Table B8: Hilti roughening tool TE-YRT – tool parameters**

Associated components			
Diamond coring		Roughening tool TE-YRT	Wear gauge RTG...
			
d <sub>0</sub> [mm]		d <sub>0</sub> [mm]	size
nominal	measured		
18	17,9 to 18,2	18	18
20	19,9 to 20,2	20	20
22	21,9 to 22,2	22	22
25	24,9 to 25,2	25	25
28	27,9 to 28,2	28	28
30	29,9 to 30,2	30	30
32	31,9 to 32,2	32	32
35	34,9 to 35,2	35	35

**Table B9: Hilti roughening tool TE-YRT – roughening and blowing times**

	Roughening time t <sub>roughen</sub>	Minimum blowing time t <sub>blowing</sub>
h <sub>ef</sub> [mm]	t <sub>roughen</sub> [sec] = h <sub>ef</sub> [mm] / 10	t <sub>blowing</sub> [sec] = t <sub>roughen</sub> [sec] + 20
0 to 100	10	30
101 to 200	20	40
201 to 300	30	50
301 to 400	40	60
401 to 500	50	70
501 to 600	60	80

**Hilti roughening tool TE-YRT and wear gauge RTG**

Hilti roughening tool TE-YRT	
Wear gauge RTG	

Injection System Hilti HIT-HY 200-A V3 and HIT-HY 200-R V3

**Intended Use**  
Parameters for use of the Hilti Roughening tool TE-YRT

**Annex B10**

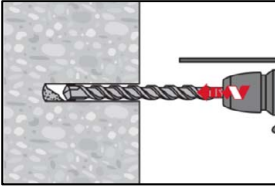
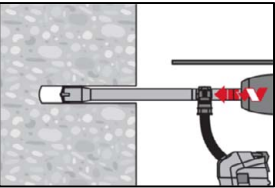
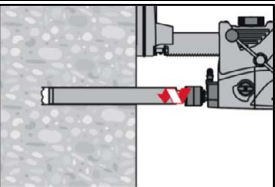
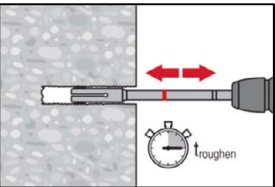
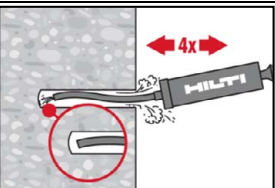
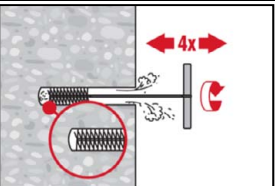
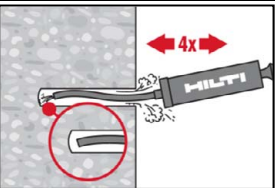
<b>Installation instruction</b>	
<b>Hole drilling</b>	
<b>a) Hammer drilling</b>	
	Drill hole to the required embedment depth with a hammer drill set in rotation-hammer mode using an appropriately sized carbide drill bit.
<b>b) Hammer drilling with Hilti hollow drill bit</b>	
	Drill hole to the required embedment depth with an appropriately sized Hilti TE-CD or TE-YD hollow drill bit with vacuum attachment following the requirements given in Table B7. This drilling system removes the dust and cleans the drill hole during drilling when used in accordance with the user's manual. After drilling is completed, proceed to the "injection preparation" step in the installation instruction.
<b>c) Diamond coring with roughening with Hilti roughening tool TE-YRT:</b>	
	Diamond coring is permissible when suitable diamond core drilling machines and the corresponding core bits are used. For the use in combination with Hilti roughening tool TE-YRT see parameters in Table B8.
	Before roughening water needs to be removed from the drill hole. Check usability of the roughening tool with the wear gauge RTG. Roughen the drill hole over the whole length to the required $h_{ef}$ . Roughening time $t_{roughen}$ see Table B9.
<b>Drill hole cleaning</b>	Just before injection of the mortar, the drill hole must be free of dust and debris. Inadequate hole cleaning = poor load values.
<b>Manual Cleaning (MC)</b> Uncracked concrete only. For drill hole diameters $d_0 \leq 20$ mm and drill hole depths $h_0 \leq 10 \cdot d$ .	
	The Hilti hand pump may be used for blowing out drill holes up to diameters $d_0 \leq 20$ mm and drill hole depths $h_0 \leq 10 \cdot d$ . Blow out at least 4 times from the back of the drill hole until return air stream is free of noticeable dust.
	Brush 4 times with the specified brush (see Table B7) by inserting the steel brush Hilti HIT-RB to the back of the hole (if needed with extension) in a twisting motion and removing it. The brush must produce natural resistance as it enters the drill hole (brush $\varnothing \geq$ drill hole $\varnothing$ ) - if not the brush is too small and must be replaced with the proper brush diameter.
	Blow out again with the Hilti hand pump at least 4 times until return air stream is free of noticeable dust.
<b>Injection System Hilti HIT-HY 200-A V3 and HIT-HY 200-R V3</b>	
<b>Intended Use</b> Installation instructions	<b>Annex B11</b>

**Compressed air cleaning (CAC) for all drill hole diameters  $d_0$  and all drill hole depths  $h_0$**

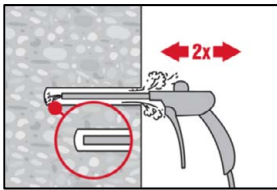

Blow 2 times from the back of the hole (if needed with nozzle extension) over the whole length with oil-free compressed air (min. 6 bar at 6 m<sup>3</sup>/h) until return air stream is free of noticeable dust.  
For drill hole diameters  $\geq 32$  mm the compressor has to supply a minimum air flow of 140 m<sup>3</sup>/h.

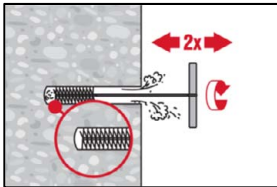

Brush 2 times with the specified brush (see Table B7) by inserting the steel brush Hilti HIT-RB to the back of the hole (if needed with extension) in a twisting motion and removing it. The brush must produce natural resistance as it enters the drill hole (brush  $\varnothing \geq$  drill hole  $\varnothing$ ) - if not the brush is too small and must be replaced with the proper brush diameter.

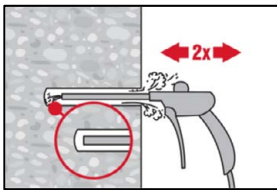

Blow again with compressed air 2 times until return air stream is free of noticeable dust.

**Cleaning of diamond cored holes with roughening with Hilti roughening tool TE-YRT.**

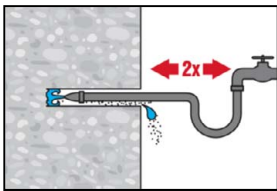

Flush 2 times by inserting a water hose (water-line pressure) to the back of the hole until water runs clear.

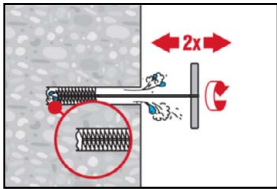

Brush 2 times with the specified brush (see Table B7) by inserting the steel brush Hilti HIT-RB to the back of the hole (if needed with extension) in a twisting motion and removing it. The brush must produce natural resistance as it enters the drill hole (brush  $\varnothing \geq$  drill hole  $\varnothing$ ) - if not the brush is too small and must be replaced with the proper brush diameter.

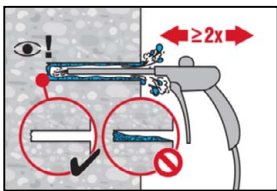

Blow 2 times from the back of the hole (if needed with nozzle extension) over the whole length with oil-free compressed air (min. 6 bar at 6 m<sup>3</sup>/h) until return air stream is free of noticeable dust and water. Remove all water from the drillhole until drillhole is completely dried before mortar injection ( $t_{\text{blowing}}$  see Table B9). For drill hole diameters  $\geq 32$  mm the compressor has to supply a minimum air flow of 140 m<sup>3</sup>/h.

**Injection System Hilti HIT-HY 200-A V3 and HIT-HY 200-R V3**

**Intended Use**  
Installation instructions

**Annex B12**

**Cleaning and water removal of water-filled drill holes drilled with hammer drilling and hammer drilling with Hilti hollow drill bit:** For all drill hole diameters  $d_0$  and all drill hole depths  $h_0$ .

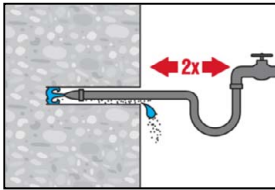

Flush 2 times by inserting a water hose (water-line pressure) to the back of the hole until water runs clear.

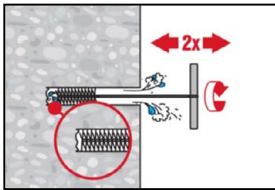

Brush 2 times with the specified brush (see Table B7) by inserting the steel brush Hilti HIT-RB to the back of the hole (if needed with extension) in a twisting motion and removing it.  
The brush must produce natural resistance as it enters the drill hole (brush  $\varnothing \geq$  drill hole  $\varnothing$ ) - if not the brush is too small and must be replaced with the proper brush diameter.

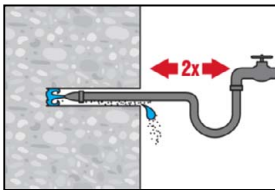

Flush 2 times by inserting a water hose (water-line pressure) to the back of the hole until water runs clear.

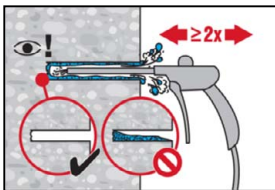

Blow 2 times from the back of the hole (if needed with nozzle extension) over the whole length with oil-free compressed air (min. 6 bar at 6 m<sup>3</sup>/h) until return air stream is free of noticeable dust and water.  
For drill hole diameters  $\geq 32$  mm the compressor has to supply a minimum air flow of 140 m<sup>3</sup>/h.

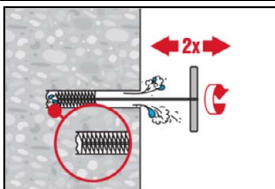

Brush 2 times with the specified brush size (see Table B7) by inserting the steel brush Hilti HIT-RB to the back of the hole (if needed with extension) in a twisting motion and removing it.  
The brush must produce natural resistance as it enters the drill hole – if not the brush is too small and must be replaced with the proper brush diameter.

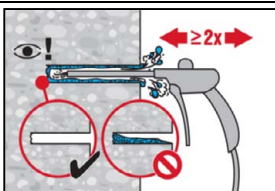

Blow again with compressed air 2 times until return air stream is free of noticeable dust and water.

**Injection System Hilti HIT-HY 200-A V3 and HIT-HY 200-R V3**

**Intended Use**  
Installation instructions

**Annex B13**

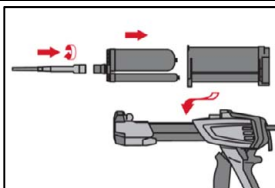
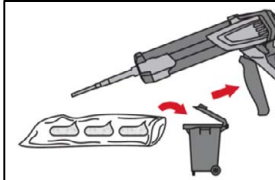
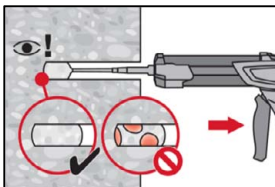
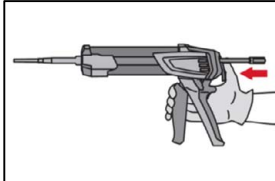
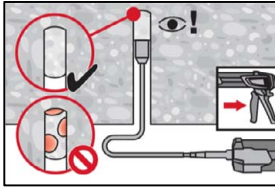
<p><b>Injection preparation</b></p>							
	<p>Tightly attach Hilti mixing nozzle HIT-RE-M to foil pack manifold. Do not modify the mixing nozzle. Observe the instruction for use of the dispenser. Check foil pack holder for proper function. Insert foil pack into foil pack holder and put holder into dispenser.</p>						
	<p>The foil pack opens automatically as dispensing is initiated. Depending on the size of the foil pack, an initial amount of adhesive has to be discarded. Discarded quantities are</p> <table border="0"> <tr> <td>2 strokes</td> <td>for 330 ml foil pack,</td> </tr> <tr> <td>3 strokes</td> <td>for 500 ml foil pack,</td> </tr> <tr> <td>4 strokes</td> <td>for 500 ml foil pack ≤ 5 °C.</td> </tr> </table> <p>The minimum foil pack temperature is 0°C.</p>	2 strokes	for 330 ml foil pack,	3 strokes	for 500 ml foil pack,	4 strokes	for 500 ml foil pack ≤ 5 °C.
2 strokes	for 330 ml foil pack,						
3 strokes	for 500 ml foil pack,						
4 strokes	for 500 ml foil pack ≤ 5 °C.						
<p><b>Inject adhesive</b> from the back of the drill hole without forming air voids.</p>							
	<p>Inject the adhesive starting at the back of the hole, slowly withdrawing the mixer with each trigger pull. Fill approximately 2/3 of the drill hole to ensure that the annular gap between the steel element and the concrete is completely filled with adhesive along the embedment length. In water saturated concrete it is required to set the fastener immediately after cleaning the drillhole.</p>						
	<p>After injection is completed, depressurize the dispenser by pressing the release trigger. This will prevent further adhesive discharge from the mixer.</p>						
	<p>Overhead installation and/or installation with embedment depth <math>h_{ef} &gt; 250\text{mm}</math>. For overhead installation the injection is only possible with the aid of extensions and piston plugs. Assemble HIT-RE-M mixer, extension(s) and appropriately sized piston plug (see Table B7). Insert piston plug to back of the hole and inject adhesive. During injection the piston plug will be naturally extruded out of the drill hole by the adhesive pressure.</p>						
<p><b>Injection System Hilti HIT-HY 200-A V3 and HIT-HY 200-R V3</b></p>							
<p><b>Intended Use</b> Installation instructions</p>	<p><b>Annex B14</b></p>						

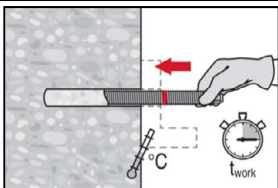
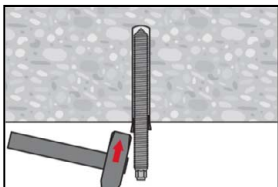
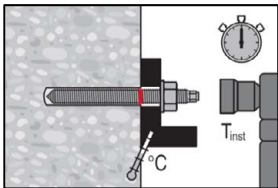
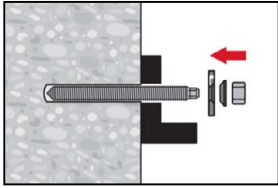
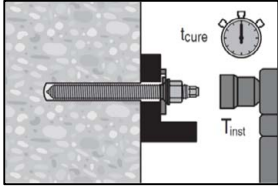
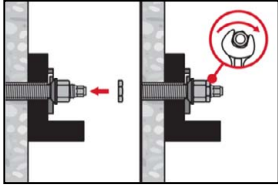
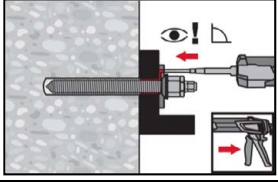
<b>Setting the steel element</b>	
	Before use, verify that the element is dry and free of oil and other contaminants. Mark and set steel element to the required embedment depth before working time $t_{work}$ has elapsed. The working time $t_{work}$ is given in Table B6.
	For overhead installation use piston plugs and fix embedded parts with e.g. wedges (Hilti HIT-OHW).
	<b>Loading:</b> After required curing time $t_{cure}$ (see Table B7) the fastening can be loaded. The applied installation torque shall not exceed the values $\max T_{inst}$ given in Table B2 to Table B4.
<b>Installation of Hilti Filling Set</b>	
	Use Hilti Filling Set with standard nut. Observe the correct orientation of filling washer and spherical washer.
	The applied installation torque shall not exceed the values $\max T_{inst}$ given in Table B2 to Table B4.
	Optional: Installation of lock nut. Tighten with a $\frac{1}{4}$ to $\frac{1}{2}$ turn. (Not for size M24.)
	Fill the annular gap between steel element and fixture with 1-3 strokes of a Hilti injection mortar HIT-HY ... or HIT-RE ... . Follow the installation instructions supplied with the respective Hilti injection mortar. After required curing time $t_{cure}$ the fastening can be loaded.
<b>Injection System Hilti HIT-HY 200-A V3 and HIT-HY 200-R V3</b>	
<b>Intended Use</b> Installation instructions	<b>Annex B15</b>

**Table C1: Essential characteristics for threaded rods according to Annex A under tension load in concrete**

Threaded rods according to Annex A			M8	M10	M12	M16	M20	M24	M27	M30	
<b>For a working life of 50 and 100 years</b>											
<b>Installation factor</b> for installation in dry or wet (water saturated) concrete											
Hammer drilling (HD)	$\gamma_{inst}$	[-]	1,0								
Hammer drilling with Hilti hollow drill bit TE-CD or TE-YD (HDB)	$\gamma_{inst}$	[-]	1)	1,0							
Diamond coring with roughening with Hilti roughening tool TE-YRT (DD+RT)	$\gamma_{inst}$	[-]	1)				1,0				
<b>Installation factor</b> for installation in water-filled drill holes (not sea water)											
Hammer drilling (HD)	$\gamma_{inst}$	[-]	1,4								
Hammer drilling with Hilti hollow drill bit TE-CD or TE-YD (HDB)	$\gamma_{inst}$	[-]	1)	1,4							
<b>Steel failure</b>											
Characteristic resistance	$N_{Rk,s}$	[kN]	$A_s \cdot f_{uk}$								
Partial factor grade 5.8, 6.8 and 8.8 (Table A1)	$\gamma_{Ms,N^{(2)}}$	[-]	1,5								
Partial factor HAS A4, HAS-U A4, HIT-V-R, Threaded rod: CRC II and III (Table A1)	$\gamma_{Ms,N^{(2)}}$	[-]	1,87						2,86		
Partial factor HAS-U HCR, HIT-V-HCR, Threaded rod: CRC V (Table A1)	$\gamma_{Ms,N^{(2)}}$	[-]	1,5				2,1				
<b>Concrete cone failure</b>											
Factor for uncracked concrete	$k_{ucr,N}$	[-]	11,0								
Factor for cracked concrete	$k_{cr,N}$	[-]	7,7								
Edge distance	$c_{cr,N}$	[mm]	$1,5 \cdot h_{ef}$								
Spacing	$s_{cr,N}$	[mm]	$3,0 \cdot h_{ef}$								
<b>Splitting failure</b>											
Edge distance $c_{cr,sp}$ [mm] for	$h / h_{ef} \geq 2,0$		$1,0 \cdot h_{ef}$								
	$2,0 > h / h_{ef} > 1,3$		$4,6 \cdot h_{ef} - 1,8 \cdot h$								
	$h / h_{ef} \leq 1,3$		$2,26 \cdot h_{ef}$								
Spacing	$s_{cr,sp}$	[mm]	$2 \cdot c_{cr,sp}$								

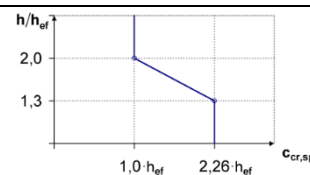

- 1) No performance assessed.  
2) In absence of national regulations.

**Injection System Hilti HIT-HY 200-A V3 and HIT-HY 200-R V3**

**Performances**  
Essential characteristics under tension load in concrete

**Annex C1**

**Table C1: continued**

Threaded rods according to Annex A	M8	M10	M12	M16	M20	M24	M27	M30
<b>Combined pullout and concrete cone failure for a working life of 50 years</b>								
Characteristic bond resistance in uncracked concrete C20/25 for installation in dry or wet (water saturated) concrete, all drilling methods (HD, HDB, DD + RT)								
Temperature range I: 24°C/40°C $\tau_{Rk,ucr}$ [N/mm <sup>2</sup> ]	18							
Temperature range II: 50°C/80°C $\tau_{Rk,ucr}$ [N/mm <sup>2</sup> ]	15							
Temperature range III: 72°C/120°C $\tau_{Rk,ucr}$ [N/mm <sup>2</sup> ]	13							
Characteristic bond resistance in cracked concrete C20/25 for installation in dry or wet (water saturated) concrete, all drilling methods (HD, HDB, DD + RT)								
Temperature range I: 24°C/40°C $\tau_{Rk,cr}$ [N/mm <sup>2</sup> ]	7,5	9,4	9,5					
Temperature range II: 50°C/80°C $\tau_{Rk,cr}$ [N/mm <sup>2</sup> ]	6,4	8,0						
Temperature range III: 72°C/120°C $\tau_{Rk,cr}$ [N/mm <sup>2</sup> ]	5,5	6,8	6,9					
Characteristic bond resistance in uncracked concrete C20/25 for installation in water-filled drill holes (not sea water), HD and HDB								
Temperature range I: 24°C/40°C $\tau_{Rk,ucr}$ [N/mm <sup>2</sup> ]	14,0	13,8	13,5	13,0	12,5	11,9	11,4	10,9
Temperature range II: 50°C/80°C $\tau_{Rk,ucr}$ [N/mm <sup>2</sup> ]	11,9	11,7	11,5	11,1	10,6	10,1	9,7	9,3
Temperature range III: 72°C/120°C $\tau_{Rk,ucr}$ [N/mm <sup>2</sup> ]	10,2	10,1	9,9	9,5	9,1	8,7	8,3	8,0
Characteristic bond resistance in cracked concrete C20/25 for installation in water-filled drill holes (not sea water), HD and HDB								
Temperature range I: 24°C/40°C $\tau_{Rk,cr}$ [N/mm <sup>2</sup> ]	6,1	7,4	7,2	6,7	6,4	6,1	6,1	6,0
Temperature range II: 50°C/80°C $\tau_{Rk,cr}$ [N/mm <sup>2</sup> ]	5,2	6,3	6,1	5,7	5,5	5,2	5,2	5,1
Temperature range III: 72°C/120°C $\tau_{Rk,cr}$ [N/mm <sup>2</sup> ]	4,5	5,4	5,2	4,9	4,7	4,5	4,5	4,4
<b>Influence factors <math>\psi</math> on bond resistance <math>\tau_{Rk}</math> in cracked and uncracked concrete</b>								
Influence of concrete strength class: $\tau_{Rk} = \tau_{Rk,(C20/25)} \cdot \psi_c$								
Temperature range I to III :	$\psi_c$	[-]	$(f_{ck}/20)^{0,1}$					
Influence of sustained load								
Temperature range I: 24°C/40°C $\psi_{sus}^0$	[-]	0,74						
Temperature range II: 50°C/80°C $\psi_{sus}^0$	[-]	0,89						
Temperature range III: 72°C/120°C $\psi_{sus}^0$	[-]	0,72						

**Injection System Hilti HIT-HY 200-A V3 and HIT-HY 200-R V3**

**Performances**  
Essential characteristics under tension load in concrete

**Annex C2**

**Table C1: continued**

Threaded rods according to Annex A	M8	M10	M12	M16	M20	M24	M27	M30
<b>Combined pullout and concrete cone failure for a working life of 100 years</b>								
Characteristic bond resistance in uncracked concrete C20/25 for installation in dry or wet (water saturated) concrete, all drilling methods (HD, HDB, DD + RT)								
Temperature range I: 24°C/40°C $\tau_{Rk,ucr,100}$ [N/mm <sup>2</sup> ]	17							
Temperature range II: 50°C/80°C $\tau_{Rk,ucr,100}$ [N/mm <sup>2</sup> ]	14							
Temperature range III: 72°C/120°C $\tau_{Rk,ucr,100}$ [N/mm <sup>2</sup> ]	12							
Characteristic bond resistance in cracked concrete C20/25 for installation in dry or wet (water saturated) concrete, all drilling methods (HD, HDB, DD + RT)								
Temperature range I: 24°C/40°C $\tau_{Rk,cr,100}$ [N/mm <sup>2</sup> ]	6,5	6,7	8,1					
Temperature range II: 50°C/80°C $\tau_{Rk,cr,100}$ [N/mm <sup>2</sup> ]	5,5	5,7	7,0					
Temperature range III: 72°C/120°C $\tau_{Rk,cr,100}$ [N/mm <sup>2</sup> ]	5,0		6,0					
Characteristic bond resistance in uncracked concrete C20/25 for installation in water-filled drill holes (not sea water), HD and HDB								
Temperature range I: 24°C/40°C $\tau_{Rk,ucr,100}$ [N/mm <sup>2</sup> ]	14,0	13,8	13,5	13,0	12,5	11,9	11,4	10,9
Temperature range II: 50°C/80°C $\tau_{Rk,ucr,100}$ [N/mm <sup>2</sup> ]	11,9	11,7	11,5	11,1	10,6	10,1	9,7	9,3
Temperature range III: 72°C/120°C $\tau_{Rk,ucr,100}$ [N/mm <sup>2</sup> ]	10,2	10,1	9,9	9,5	9,1	8,7	8,3	8,0
Characteristic bond resistance in cracked concrete C20/25 for installation in water-filled drill holes (not sea water), HD and HDB								
Temperature range I: 24°C/40°C $\tau_{Rk,cr,100}$ [N/mm <sup>2</sup> ]	5,5	5,3	6,1	5,8	5,5	5,3	5,1	4,8
Temperature range II: 50°C/80°C $\tau_{Rk,cr,100}$ [N/mm <sup>2</sup> ]	4,5	4,5	5,2	4,9	4,7	4,5	4,3	4,1
Temperature range III: 72°C/120°C $\tau_{Rk,cr,100}$ [N/mm <sup>2</sup> ]	3,9	3,8	4,5	4,2	4,0	3,8	3,7	3,5
<b>Influence factors <math>\psi</math> on bond resistance <math>\tau_{Rk,100}</math> in cracked and uncracked concrete</b>								
Influence of concrete strength class: $\tau_{Rk} = \tau_{Rk,(C20/25)} \cdot \psi_c$								
Temperature range I to III :	$\psi_c$	[-]	$(f_{ck}/20)^{0,1}$					
Influence of sustained load								
Temperature range I: 24°C/40°C $\psi_{sus,100}^0$	[-]	0,71						
Temperature range II: 50°C/80°C $\psi_{sus,100}^0$	[-]	0,86						
Temperature range III: 72°C/120°C $\psi_{sus,100}^0$	[-]	0,80						

**Injection System Hilti HIT-HY 200-A V3 and HIT-HY 200-R V3**

**Performances**  
Essential characteristics under tension load in concrete

**Annex C3**

**Table C2: Essential characteristics for threaded rods according to Annex A under shear load in concrete**

Threaded rods according to Annex A		M8	M10	M12	M16	M20	M24	M27	M30	
<b>For a working life of 50 and 100 years</b>										
<b>Steel failure without lever arm</b>										
Characteristic resistance	$V_{Rk,s}^0$ [kN]	$k_6 \cdot A_s \cdot f_{uk}$								
Factor grade 5.8	$k_6$ [-]	0,6								
Factor grade 6.8 and 8.8	$k_6$ [-]	0,5								
Factor HAS A4, HAS-U A4, HIT-V-R, Threaded rod: CRC II and III (Table A1)	$k_6$ [-]	0,5								
Factor HAS-U HCR, HIT-V-HCR, Threaded rod: CRC V (Table A1)	$k_6$ [-]	0,5								
Partial factor grade 5.8, 6.8, 8.8	$\gamma_{Ms,V}^{1)}$ [-]	1,25								
Partial factor HAS A4, HAS-U A4, HIT-V-R, Threaded rod CRC II and III (Table A1)	$\gamma_{Ms,V}^{1)}$ [-]	1,56						2,38		
Partial factor HAS-U HCR, HIT-V-HCR, Threaded rod CRC V (Table A1)	$\gamma_{Ms,V}^{1)}$ [-]	1,25				1,75				
Ductility factor	$k_7$ [-]	1,0								
<b>Steel failure with lever arm</b>										
Characteristic resistance	$M_{Rk,s}^0$ [Nm]	$1,2 \cdot W_{el} \cdot f_{uk}$								
Ductility factor	$k_7$ [-]	1,0								
<b>Concrete pry-out failure</b>										
Pry-out factor	$k_8$ [-]	2,0								
<b>Concrete edge failure</b>										
Effective length of fastener	$l_f$ [mm]	$\min(h_{ef}, 12 \cdot d_{nom})$							$\min(h_{ef}, 8 \cdot d_{nom}, 300)$	
Outside diameter of fastener	$d_{nom}$ [mm]	8	10	12	16	20	24	27	30	

<sup>1)</sup> In absence of national regulations.

**Injection System Hilti HIT-HY 200-A V3 and HIT-HY 200-R V3**

**Performances**  
Essential characteristics under shear load in concrete

**Annex C4**

**Table C3: Essential characteristics for internally threaded sleeve HIS-(R)N under tension load in concrete**

HIS-(R)N			M8	M10	M12	M16	M20	
<b>For a working life of 50 years</b>								
<b>Installation factor</b>								
Hammer drilling	$\gamma_{inst}$	[-]	1,0					
Hammer drilling with Hilti hollow drill bit TE-CD or TE-YD	$\gamma_{inst}$	[-]	1,0					
Diamond coring with roughening with Hilti roughening tool TE-YRT	$\gamma_{inst}$	[-]	1)	1,0				
<b>Steel failure</b>								
Characteristic resistance HIS-N with screw or threaded rod grade 8.8	$N_{Rk,s}$	[kN]	25	46	67	125	116	
Partial factor	$\gamma_{Ms,N^2)}$	[-]	1,50					
Characteristic resistance HIS-RN with screw or threaded rod grade 70	$N_{Rk,s}$	[kN]	26	41	59	110	166	
Partial factor	$\gamma_{Ms,N^2)}$	[-]	1,87					2,4
<b>Concrete cone failure</b>								
Factor for uncracked concrete	$k_{ucr,N}$	[-]	11,0					
Factor for cracked concrete	$k_{cr,N}$	[-]	7,7					
Edge distance	$c_{cr,N}$	[mm]	$1,5 \cdot h_{ef}$					
Spacing	$s_{cr,N}$	[mm]	$3,0 \cdot h_{ef}$					
<b>Splitting failure</b>								
Edge distance $c_{cr,sp}$ [mm] for	$h / h_{ef} \geq 2,0$		$1,0 \cdot h_{ef}$					
	$2,0 > h / h_{ef} > 1,3$		$4,6 h_{ef} - 1,8 h$					
	$h / h_{ef} \leq 1,3$		$2,26 h_{ef}$					
Spacing	$s_{cr,sp}$	[mm]	$2 \cdot c_{cr,sp}$					

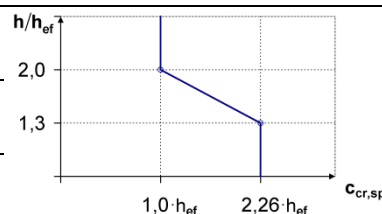

- 1) No performance assessed.  
2) In absence of national regulations.

**Injection System Hilti HIT-HY 200-A V3 and HIT-HY 200-R V3**

**Performances**  
Essential characteristics under tension load in concrete

**Annex C5**

**Table C3: continued**

HIS-(R)N	M8	M10	M12	M16	M20
<b>Combined pullout and concrete cone failure for a working life of 50 years</b>					
Effective embedment depth $h_{ef}$ [mm]	90	110	125	170	205
Effective fastener diameter $d_1$ [mm]	12,5	16,5	20,5	25,4	27,6
Characteristic bond resistance in uncracked concrete C20/25 for installation in dry or wet (water saturated) concrete, all drilling methods (HD, HDB, DD + RT)					
Temperature range I: 24°C/40°C $\tau_{Rk,ucr}$ [N/mm <sup>2</sup> ]	13				
Temperature range II: 50°C/80°C $\tau_{Rk,ucr}$ [N/mm <sup>2</sup> ]	11				
Temperature range III: 72°C/120°C $\tau_{Rk,ucr}$ [N/mm <sup>2</sup> ]	9,5				
Characteristic bond resistance in cracked concrete C20/25 for installation in dry or wet (water saturated) concrete, all drilling methods (HD, HDB, DD + RT)					
Temperature range I: 24°C/40°C $\tau_{Rk,cr}$ [N/mm <sup>2</sup> ]	7				
Temperature range II: 50°C/80°C $\tau_{Rk,cr}$ [N/mm <sup>2</sup> ]	5,5				
Temperature range III: 72°C/120°C $\tau_{Rk,cr}$ [N/mm <sup>2</sup> ]	5				
<b>Influence factors <math>\psi</math> on bond resistance <math>\tau_{Rk}</math> in cracked and uncracked concrete</b>					
Influence of concrete strength class: $\tau_{Rk} = \tau_{Rk,(C20/25)} \cdot \psi_c$					
Temperature range I to III : $\psi_c$ [-]	$(f_{ck}/20)^{0,1}$				
Influence of sustained load					
Temperature range I: 24°C/40°C $\psi_{sus}^0$ [-]	0,74				
Temperature range II: 50°C/80°C $\psi_{sus}^0$ [-]	0,89				
Temperature range III: 72°C/120°C $\psi_{sus}^0$ [-]	0,72				

**Injection System Hilti HIT-HY 200-A V3 and HIT-HY 200-R V3**

**Performances**  
Essential characteristics under tension load in concrete

**Annex C6**

**Table C4: Essential characteristics for internally threaded sleeve HIS-(R)N under shear load in concrete**

HIS-(R)N		M8	M10	M12	M16	M20
<b>For a working life of 50 years</b>						
<b>Steel failure without lever arm</b>						
Characteristic resistance HIS-N with screw or threaded rod grade 8.8	$V_{Rk,s}^0$ [kN]	13	23	34	63	58
Partial factor	$\gamma_{Ms,V}^{1)}$ [-]	1,25				
Characteristic resistance HIS-RN with screw or threaded rod grade 70	$V_{Rk,s}^0$ [kN]	13	20	30	55	83
Partial factor	$\gamma_{Ms,V}^{1)}$ [-]	1,56				2,0
Ductility factor	$k_7$ [-]	1,0				
<b>Steel failure with lever arm</b>						
Characteristic resistance HIS-N with screw or threaded rod grade 8.8	$M_{Rk,s}^0$ [Nm]	30	60	105	266	519
Characteristic resistance HIS-RN with screw or threaded rod grade 70	$M_{Rk,s}^0$ [Nm]	26	52	92	233	454
Ductility factor	$k_7$ [-]	1,0				
<b>Concrete pry-out failure</b>						
Pry-out factor	$k_8$ [-]	2,0				
<b>Concrete edge failure</b>						
Effective length of fastener	$l_f$ [mm]	90	110	125	170	205
Outside diameter of fastener	$d_{nom}$ [mm]	12,5	16,5	20,5	25,4	27,6

<sup>1)</sup> In absence of national regulations.

**Injection System Hilti HIT-HY 200-A V3 and HIT-HY 200-R V3**

**Performances**  
Essential characteristics under shear load in concrete

**Annex C7**

**Table C5: Essential characteristics for Hilti tension anchor HZA / HZA-R under tension load in concrete**

Hilti tension anchor HZA, HZA-R				M12	M16	M20	M24	M27
<b>For a working life of 50 and 100 years</b>								
<b>Installation factor</b> for installation in dry or wet (water saturated) concrete								
Hammer drilling	$\gamma_{inst}$	[-]				1,0		
Hammer drilling with Hilti hollow drill bit TE-CD or TE-YD	$\gamma_{inst}$	[-]				1,0		
Diamond coring with roughening with Hilti roughening tool TE-YRT	$\gamma_{inst}$	[-]	1)			1,0		
<b>Installation factor</b> for installation in water-filled drill holes (not sea water)								
Hammer drilling	$\gamma_{inst}$	[-]				1,4		
Hammer drilling with Hilti hollow drill bit TE-CD or TE-YD	$\gamma_{inst}$	[-]				1,4		
<b>Steel failure</b>								
Characteristic resistance HZA	$N_{Rk,s}$	[kN]	46	86	135	194	253	
Characteristic resistance HZA-R	$N_{Rk,s}$	[kN]	62	111	173	248		1)
Partial factor	$\gamma_{Ms,N^2)}$	[-]				1,4		
<b>Concrete cone failure</b>								
Effective anchorage depth	HZA	$h_{ef}$	[mm]	$h_{nom}$				
	HZA-R	$h_{ef}$	[mm]	$h_{nom}$				
								1)
Factor for uncracked concrete	$k_{ucr,N}$	[-]	11,0					
Factor for cracked concrete	$k_{cr,N}$	[-]	7,7					
Edge distance	$c_{cr,N}$	[mm]	$1,5 \cdot h_{ef}$					
Spacing	$s_{cr,N}$	[mm]	$3,0 \cdot h_{ef}$					
<b>Splitting failure relevant for uncracked concrete</b>								
Edge distance $c_{cr,sp}$ [mm] for	$h / h_{ef} \geq 2,0$		$1,0 \cdot h_{ef}$					
	$2,0 > h / h_{ef} > 1,3$		$4,6 \cdot h_{ef} - 1,8 \cdot h$					
	$h / h_{ef} \leq 1,3$		$2,26 \cdot h_{ef}$					
Spacing	$s_{cr,sp}$	[mm]	$2 \cdot c_{cr,sp}$					

1) No performance assessed.  
2) In absence of national regulations.

**Injection System Hilti HIT-HY 200-A V3 and HIT-HY 200-R V3**

**Performances**  
Essential characteristics under tension load in concrete

**Annex C8**

**Table C5: continued**

<b>Hilti tension anchor HZA, HZA-R</b>				<b>M12</b>	<b>M16</b>	<b>M20</b>	<b>M24</b>	<b>M27</b>
Diameter of rebar	d	[mm]		12	16	20	25	28
Effective anchorage depth	HZA	$h_{ef}$	[mm]	$h_{nom} - 20$				
	HZA-R	$h_{ef}$	[mm]	$h_{nom} - 100$				
<b>Combined pull-out and concrete cone failure for a working life of 50 years</b>								
Characteristic bond resistance in uncracked concrete C20/25 for installation in dry or wet (water saturated) concrete, all drilling methods (HD, HDB, DD + RT)								
Temperature range I:	24°C/40°C	$\tau_{Rk,ucr}$	[N/mm <sup>2</sup> ]	12				
Temperature range II:	50°C/80°C	$\tau_{Rk,ucr}$	[N/mm <sup>2</sup> ]	10				
Temperature range III:	72°C/120°C	$\tau_{Rk,ucr}$	[N/mm <sup>2</sup> ]	8,5				
Characteristic bond resistance in cracked concrete C20/25 for installation in dry or wet (water saturated) concrete, all drilling methods (HD, HDB, DD + RT)								
Temperature range I:	24°C/40°C	$\tau_{Rk,cr}$	[N/mm <sup>2</sup> ]	7				
Temperature range II:	50°C/80°C	$\tau_{Rk,cr}$	[N/mm <sup>2</sup> ]	5,5				
Temperature range III:	72°C/120°C	$\tau_{Rk,cr}$	[N/mm <sup>2</sup> ]	5				
Characteristic bond resistance in uncracked concrete C20/25 for installation in water-filled drill holes (not sea water), HD and HDB								
Temperature range I:	24°C/40°C	$\tau_{Rk,ucr}$	[N/mm <sup>2</sup> ]	11,4				
Temperature range II:	50°C/80°C	$\tau_{Rk,ucr}$	[N/mm <sup>2</sup> ]	9,3				
Temperature range III:	72°C/120°C	$\tau_{Rk,ucr}$	[N/mm <sup>2</sup> ]	8,1				
Characteristic bond resistance in cracked concrete C20/25 for installation in water-filled drill holes (not sea water), HD and HDB								
Temperature range I:	24°C/40°C	$\tau_{Rk,cr}$	[N/mm <sup>2</sup> ]	6,5				
Temperature range II:	50°C/80°C	$\tau_{Rk,cr}$	[N/mm <sup>2</sup> ]	5,2				
Temperature range III:	72°C/120°C	$\tau_{Rk,cr}$	[N/mm <sup>2</sup> ]	4,5				
<b>Influence factors <math>\psi</math> on bond resistance <math>\tau_{Rk}</math> in cracked and uncracked concrete</b>								
Influence of concrete strength class: $\tau_{Rk} = \tau_{Rk,(C20/25)} \cdot \psi_c$								
Temperature range I to III :	$\psi_c$	[-]		$(f_{ck}/20)^{0,1}$				
Influence of sustained load								
Temperature range I:	24°C/40°C	$\psi_{sUS}^0$	[-]	0,74				
Temperature range II:	50°C/80°C	$\psi_{sUS}^0$	[-]	0,89				
Temperature range III:	72°C/120°C	$\psi_{sUS}^0$	[-]	0,72				

**Injection System Hilti HIT-HY 200-A V3 and HIT-HY 200-R V3**

**Performances**  
Essential characteristics under tension load in concrete

**Annex C9**

**Table C5: continued**

<b>Hilti tension anchor HZA, HZA-R</b>				<b>M12</b>	<b>M16</b>	<b>M20</b>	<b>M24</b>	<b>M27</b>
Diameter of rebar	d	[mm]		12	16	20	25	28
Effective anchorage depth	HZA	$h_{ef}$	[mm]	$h_{nom} - 20$				
	HZA-R	$h_{ef}$	[mm]	$h_{nom} - 100$				
<b>Combined pull-out and concrete cone failure for a working life 100 years</b>								
Characteristic bond resistance in uncracked concrete C20/25 for installation in dry or wet (water saturated) concrete, all drilling methods (HD, HDB, DD + RT)								
Temperature range I:	24°C/40°C	$\tau_{RK,ucr,100}$	[N/mm <sup>2</sup> ]	12				
Temperature range II:	50°C/80°C	$\tau_{RK,ucr,100}$	[N/mm <sup>2</sup> ]	10				
Temperature range III:	72°C/120°C	$\tau_{RK,ucr,100}$	[N/mm <sup>2</sup> ]	8,5				
Characteristic bond resistance in cracked concrete C20/25 for installation in dry or wet (water saturated) concrete, all drilling methods (HD, HDB, DD + RT)								
Temperature range I:	24°C/40°C	$\tau_{RK,cr,100}$	[N/mm <sup>2</sup> ]	7				
Temperature range II:	50°C/80°C	$\tau_{RK,cr,100}$	[N/mm <sup>2</sup> ]	5,5				
Temperature range III:	72°C/120°C	$\tau_{RK,cr,100}$	[N/mm <sup>2</sup> ]	5				
Characteristic bond resistance in uncracked concrete C20/25 for installation in water-filled drill holes (not sea water), HD and HDB								
Temperature range I:	24°C/40°C	$\tau_{RK,ucr,100}$	[N/mm <sup>2</sup> ]	11,4				
Temperature range II:	50°C/80°C	$\tau_{RK,ucr,100}$	[N/mm <sup>2</sup> ]	9,3				
Temperature range III:	72°C/120°C	$\tau_{RK,ucr,100}$	[N/mm <sup>2</sup> ]	8,1				
Characteristic bond resistance in cracked concrete C20/25 for installation in water-filled drill holes (not sea water), HD and HDB								
Temperature range I:	24°C/40°C	$\tau_{RK,cr,100}$	[N/mm <sup>2</sup> ]	6,5				
Temperature range II:	50°C/80°C	$\tau_{RK,cr,100}$	[N/mm <sup>2</sup> ]	5,2				
Temperature range III:	72°C/120°C	$\tau_{RK,cr,100}$	[N/mm <sup>2</sup> ]	4,5				
<b>Influence factors <math>\psi</math> on bond resistance <math>\tau_{RK}</math> in cracked and uncracked concrete</b>								
Influence of concrete strength class: $\tau_{RK} = \tau_{RK,(C20/25)} \cdot \psi_c$								
Temperature range I to III :	$\psi_c$	[-]		$(f_{ck}/20)^{0,1}$				
Influence of sustained load								
Temperature range I:	24°C/40°C	$\psi^0_{sus,100}$	[-]	0,71				
Temperature range II:	50°C/80°C	$\psi^0_{sus,100}$	[-]	0,86				
Temperature range III:	72°C/120°C	$\psi^0_{sus,100}$	[-]	0,80				

<sup>1)</sup> No performance assessed

**Injection System Hilti HIT-HY 200-A V3 and HIT-HY 200-R V3**

**Performances**  
Essential characteristics under tension load in concrete

**Annex C10**

**Table C6: Essential characteristics for Hilti tension anchor HZA, HZA-R under shear load in concrete**

Hilti tension anchor HZA, HZA-R		M12	M16	M20	M24	M27
<b>For a working life of 50 and 100 years</b>						
<b>Steel failure without lever arm</b>						
Characteristic resistance HZA	$V^0_{Rk,s}$ [kN]	23	43	67	97	126
Characteristic resistance HZA-R	$V^0_{Rk,s}$ [kN]	31	55	86	124	<sup>1)</sup>
Partial factor	$\gamma_{Ms,V^2)}$ [-]	1,5				
Ductility factor	$k_7$ [-]	1,0				
<b>Steel failure with lever arm</b>						
Characteristic resistance HZA	$M^0_{Rk,s}$ [Nm]	72	183	357	617	915
Characteristic resistance HZA-R	$M^0_{Rk,s}$ [Nm]	97	234	457	790	<sup>1)</sup>
Ductility factor	$k_7$ [-]	1,0				
<b>Concrete pry-out failure</b>						
Pry-out factor	$k_8$ [-]	2,0				
<b>Concrete edge failure</b>						
Effective length of fastener	$l_f$ [mm]	$\min(h_{nom}; 12 \cdot d_{nom})$				$\min(h_{nom}; 8 \cdot d_{nom}; 300)$
Outside diameter of fastener	$d_{nom}$ [mm]	12	16	20	24	27

<sup>1)</sup> No performance assessed.

<sup>2)</sup> In absence of national regulations.

**Injection System Hilti HIT-HY 200-A V3 and HIT-HY 200-R V3**

**Performances**  
Essential characteristics under shear load in concrete

**Annex C11**

**Table C7: Essential characteristics for rebar under tension load in concrete**

Rebar		φ 8	φ 10	φ 12	φ 14	φ 16	φ 20	φ 25	φ 26	φ 28	φ 30	φ 32	
<b>For a working life of 50 and 100 years</b>													
<b>Installation factor</b> for installation in dry or wet (water saturated) concrete													
Hammer drilling	$\gamma_{inst}$	[-]						1,0					
Hammer drilling with Hilti hollow drill bit TE-CD or TE-YD	$\gamma_{inst}$	[-]						1,0					
Diamond coring with roughening with Hilti roughening tool TE-YRT	$\gamma_{inst}$	[-]						1) 1,0					
<b>Installation factor</b> for installation in water-filled drill holes (not sea water)													
Hammer drilling	$\gamma_{inst}$	[-]						1,4					
Hammer drilling with Hilti hollow drill bit TE-CD or TE-YD	$\gamma_{inst}$	[-]						1,4					
<b>Steel failure</b>													
Characteristic resistance	$N_{Rk,s}$	[kN]		$A_s \cdot f_{uk}^{2)}$									
Characteristic resistance Rebar B500B acc. to DIN 488-1	$N_{Rk,s}$	[kN]	28	43	62	85	111	173	270	292	339	388	442
Partial factor	$\gamma_{Ms,N}^{3)}$	[-]						1,4					
<b>Concrete cone failure</b>													
Factor for uncracked concrete	$k_{ucr,N}$	[-]						11,0					
Factor for cracked concrete	$k_{cr,N}$	[-]						7,7					
Edge distance	$c_{cr,N}$	[mm]						$1,5 \cdot h_{ef}$					
Spacing	$s_{cr,N}$	[mm]						$3,0 \cdot h_{ef}$					
<b>Splitting failure relevant for uncracked concrete</b>													
Edge distance $c_{cr,sp}$ [mm] for	$h / h_{ef} \geq 2,0$		$1,0 \cdot h_{ef}$										
	$2,0 > h / h_{ef} > 1,3$		$4,6 \cdot h_{ef} - 1,8 \cdot h$										
	$h / h_{ef} \leq 1,3$		$2,26 \cdot h_{ef}$										
Spacing	$s_{cr,sp}$	[mm]						$2 c_{cr,sp}$					

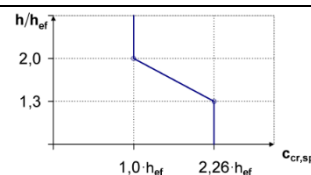

- 1) No performance assessed.
- 2)  $f_{uk}$  according to rebar specification.
- 3) In absence of national regulations.

**Injection System Hilti HIT-HY 200-A V3 and HIT-HY 200-R V3**

**Performances**  
Essential characteristics under tension load in concrete

**Annex C12**

**Table C7: continued**

Rebar	φ 8	φ 10	φ 12	φ 14	φ 16	φ 20	φ 25	φ 26	φ 28	φ 30	φ 32
Diameter of rebar d [mm]	8	10	12	14	16	20	25	26	28	30	32
<b>Combined pull-out and concrete cone failure for a working life of 50 years</b>											
Characteristic bond resistance in uncracked concrete C20/25 for installation in dry or wet (water saturated) concrete, all drilling methods (HD, HDB, DD + RT)											
Temperature range I: 24°C/40°C $\tau_{Rk,ucr}$ [N/mm <sup>2</sup> ]	12										
Temperature range II: 50°C/80°C $\tau_{Rk,ucr}$ [N/mm <sup>2</sup> ]	10										
Temperature range III: 72°C/120°C $\tau_{Rk,ucr}$ [N/mm <sup>2</sup> ]	8,5										
Characteristic bond resistance in cracked concrete C20/25 for installation in dry or wet (water saturated) concrete, all drilling methods (HD, HDB, DD + RT)											
Temperature range I: 24°C/40°C $\tau_{Rk,cr}$ [N/mm <sup>2</sup> ]	1)	5,0	7,0								
Temperature range II: 50°C/80°C $\tau_{Rk,cr}$ [N/mm <sup>2</sup> ]	1)	4,0	5,5								
Temperature range III: 72°C/120°C $\tau_{Rk,cr}$ [N/mm <sup>2</sup> ]	1)	3,5	5,0								
Characteristic bond resistance in uncracked concrete C20/25 for installation in water-filled drill holes (not sea water), HD and HDB											
Temperature range I: 24°C/40°C $\tau_{Rk,ucr}$ [N/mm <sup>2</sup> ]	1)	11,4									
Temperature range II: 50°C/80°C $\tau_{Rk,ucr}$ [N/mm <sup>2</sup> ]	1)	9,3									
Temperature range III: 72°C/120°C $\tau_{Rk,ucr}$ [N/mm <sup>2</sup> ]	1)	8,1									
Characteristic bond resistance in cracked concrete C20/25 for installation in water-filled drill holes (not sea water), HD and HDB											
Temperature range I: 24°C/40°C $\tau_{Rk,cr}$ [N/mm <sup>2</sup> ]	1)	4,6	6,5								
Temperature range II: 50°C/80°C $\tau_{Rk,cr}$ [N/mm <sup>2</sup> ]	1)	3,7	5,2								
Temperature range III: 72°C/120°C $\tau_{Rk,cr}$ [N/mm <sup>2</sup> ]	1)	3,2	4,5								
<b>Influence factors <math>\psi</math> on bond resistance <math>\tau_{Rk}</math> in cracked and uncracked concrete</b>											
Influence of concrete strength class: $\tau_{Rk} = \tau_{Rk,(C20/25)} \cdot \psi_c$											
Temperature range I to III :	$\psi_c$	[-]	$(f_{ck}/20)^{0,1}$								
Influence of sustained load											
Temperature range I: 24°C/40°C $\psi_{sus}^0$	[-]	0,74									
Temperature range II: 50°C/80°C $\psi_{sus}^0$	[-]	0,89									
Temperature range III: 72°C/120°C $\psi_{sus}^0$	[-]	0,72									

**Injection System Hilti HIT-HY 200-A V3 and HIT-HY 200-R V3**

**Performances**  
Essential characteristics under tension load in concrete

**Annex C13**

**Table C7: continued**

Rebar	φ 8	φ 10	φ 12	φ 14	φ 16	φ 20	φ 25	φ 26	φ 28	φ 30	φ 32
Diameter of rebar d [mm]	8	10	12	14	16	20	25	26	28	30	32
<b>Combined pull-out and concrete cone failure for a working life of 100 years</b>											
Characteristic bond resistance in uncracked concrete C20/25 for installation in dry or wet (water saturated) concrete, all drilling methods (HD, HDB, DD + RT)											
Temperature range I: 24°C/40°C $\tau_{Rk,ucr,100}$ [N/mm <sup>2</sup> ]	12										
Temperature range II: 50°C/80°C $\tau_{Rk,ucr,100}$ [N/mm <sup>2</sup> ]	10										
Temperature range III: 72°C/120°C $\tau_{Rk,ucr,100}$ [N/mm <sup>2</sup> ]	8,5										
Characteristic bond resistance in cracked concrete C20/25 for installation in dry or wet (water saturated) concrete, all drilling methods (HD, HDB, DD + RT)											
Temperature range I: 24°C/40°C $\tau_{Rk,cr,100}$ [N/mm <sup>2</sup> ]	<sup>1)</sup>	5,0	7,0								
Temperature range II: 50°C/80°C $\tau_{Rk,cr,100}$ [N/mm <sup>2</sup> ]	<sup>1)</sup>	4,0	5,5								
Temperature range III: 72°C/120°C $\tau_{Rk,cr,100}$ [N/mm <sup>2</sup> ]	<sup>1)</sup>	3,5	5,0								
Characteristic bond resistance in uncracked concrete C20/25 for installation in water-filled drill holes (not sea water), HD and HDB											
Temperature range I: 24°C/40°C $\tau_{Rk,ucr,100}$ [N/mm <sup>2</sup> ]	<sup>1)</sup>	11,4									
Temperature range II: 50°C/80°C $\tau_{Rk,ucr,100}$ [N/mm <sup>2</sup> ]	<sup>1)</sup>	9,3									
Temperature range III: 72°C/120°C $\tau_{Rk,ucr,100}$ [N/mm <sup>2</sup> ]	<sup>1)</sup>	8,1									
Characteristic bond resistance in cracked concrete C20/25 for installation in water-filled drill holes (not sea water), HD and HDB											
Temperature range I: 24°C/40°C $\tau_{Rk,cr,100}$ [N/mm <sup>2</sup> ]	<sup>1)</sup>	4,6	6,5								
Temperature range II: 50°C/80°C $\tau_{Rk,cr,100}$ [N/mm <sup>2</sup> ]	<sup>1)</sup>	3,7	5,2								
Temperature range III: 72°C/120°C $\tau_{Rk,cr,100}$ [N/mm <sup>2</sup> ]	<sup>1)</sup>	3,2	4,5								
<b>Influence factors <math>\psi</math> on bond resistance <math>\tau_{Rk}</math> in cracked and uncracked concrete</b>											
Influence of concrete strength class: $\tau_{Rk} = \tau_{Rk,(C20/25)} \cdot \psi_c$											
Temperature range I to III :	$\psi_c$	[-]	$(f_{ck}/20)^{0,1}$								
Influence of sustained load											
Temperature range I: 24°C/40°C $\psi_{sus,100}^0$	[-]	0,71									
Temperature range II: 50°C/80°C $\psi_{sus,100}^0$	[-]	0,86									
Temperature range III: 72°C/120°C $\psi_{sus,100}^0$	[-]	0,80									

<sup>1)</sup> No performance assessed.

**Injection System Hilti HIT-HY 200-A V3 and HIT-HY 200-R V3**

**Performances**  
Essential characteristics under tension load in concrete

**Annex C14**

**Table C8: Essential characteristics for rebar under shear load in concrete**

Rebar	$\phi$ 8	$\phi$ 10	$\phi$ 12	$\phi$ 14	$\phi$ 16	$\phi$ 20	$\phi$ 25	$\phi$ 26	$\phi$ 28	$\phi$ 30	$\phi$ 32	
<b>For a working life of 50 and 100 years</b>												
<b>Steel failure without lever arm</b>												
Characteristic resistance	$V_{RK,s}^0$ [kN]	$0,5 \cdot A_s \cdot f_{uk}^{1)}$										
Characteristic resistance Rebar B500B acc. to DIN 488-1	$V_{RK,s}^0$ [kN]	14	22	31	42	55	86	135	146	169	194	221
Partial factor	$\gamma_{Ms,V}^{2)}$ [-]	1,5										
Ductility factor	$k_7$ [-]	1,0										
<b>Steel failure with lever arm</b>												
Characteristic resistance	$M_{RK,s}^0$ [Nm]	$1,2 \cdot W_{el} \cdot f_{uk}^{1)}$										
Characteristic resistance Rebar B500B acc. to DIN 488-1	$M_{RK,s}^0$ [Nm]	33	65	112	178	265	518	1012	1139	1422	1749	2123
Ductility factor	$k_7$ [-]	1,0										
<b>Concrete pry-out failure</b>												
Pry-out factor	$k_8$ [-]	2,0										
<b>Concrete edge failure</b>												
Effective length of fastener	$l_f$ [mm]	$\min(h_{ef}; 12 \cdot d_{nom})$						$\min(h_{nom}; 8 \cdot d_{nom}; 300)$				
Outside diameter of fastener	$d_{nom}$ [mm]	8	10	12	14	16	20	25	26	28	30	32

1)  $f_{uk}$  according to rebar specification

2) In absence of national regulations.

**Injection System Hilti HIT-HY 200-A V3 and HIT-HY 200-R V3**

**Performances**  
Essential characteristics under shear load in concrete

**Annex C15**

**Table C9: Displacements under tension load**

Threaded rods according to Annex A			M8	M10	M12	M16	M20	M24	M27	M30	
Uncracked concrete temperature range I: 24°C / 40°C											
Displacement	$\delta_{N0}$	[mm/(N/mm <sup>2</sup> )]	0,02	0,03	0,03	0,04	0,06	0,07	0,07	0,08	
	$\delta_{N\infty}$	[mm/(N/mm <sup>2</sup> )]	0,04	0,05	0,06	0,08	0,10	0,13	0,14	0,16	
Uncracked concrete temperature range II: 50°C / 80°C											
Displacement	$\delta_{N0}$	[mm/(N/mm <sup>2</sup> )]	0,03	0,04	0,05	0,06	0,08	0,09	0,10	0,12	
	$\delta_{N\infty}$	[mm/(N/mm <sup>2</sup> )]	0,04	0,05	0,06	0,09	0,11	0,13	0,15	0,16	
Uncracked concrete temperature range III: 72°C / 120°C											
Displacement	$\delta_{N0}$	[mm/(N/mm <sup>2</sup> )]	0,04	0,05	0,06	0,08	0,10	0,12	0,13	0,16	
	$\delta_{N\infty}$	[mm/(N/mm <sup>2</sup> )]	0,04	0,05	0,07	0,09	0,11	0,13	0,15	0,17	
Cracked concrete temperature range I: 24°C / 40°C											
Displacement	$\delta_{N0}$	[mm/(N/mm <sup>2</sup> )]					0,07				
	$\delta_{N\infty}$	[mm/(N/mm <sup>2</sup> )]					0,16				
Cracked concrete temperature range II: 50°C / 80°C											
Displacement	$\delta_{N0}$	[mm/(N/mm <sup>2</sup> )]					0,10				
	$\delta_{N\infty}$	[mm/(N/mm <sup>2</sup> )]					0,22				
Cracked concrete temperature range III: 72°C / 120°C											
Displacement	$\delta_{N0}$	[mm/(N/mm <sup>2</sup> )]					0,13				
	$\delta_{N\infty}$	[mm/(N/mm <sup>2</sup> )]					0,29				

**Table C10: Displacements under shear load**

Threaded rods according to Annex A			M8	M10	M12	M16	M20	M24	M27	M30
Displacement	$\delta_{V0}$	[mm/kN]	0,06	0,06	0,05	0,04	0,04	0,03	0,03	0,03
	$\delta_{V\infty}$	[mm/kN]	0,09	0,08	0,08	0,06	0,06	0,05	0,05	0,05

**Injection System Hilti HIT-HY 200-A V3 and HIT-HY 200-R V3**

**Performances**

Displacements with threaded rod, HAS-U-..., HIT-V-... and AM 8.8

**Annex C16**

**Table C11: Displacements under tension load**

HIS-(R)N		M8	M10	M12	M16	M20
Uncracked concrete temperature range I: 24°C / 40°C						
Displacement	$\delta_{N0}$ [mm/(N/mm <sup>2</sup> )]	0,03	0,05	0,06	0,07	0,08
	$\delta_{N\infty}$ [mm/(N/mm <sup>2</sup> )]	0,06	0,09	0,11	0,13	0,14
Uncracked concrete temperature range II: 50°C / 80°C						
Displacement	$\delta_{N0}$ [mm/(N/mm <sup>2</sup> )]	0,05	0,06	0,08	0,10	0,11
	$\delta_{N\infty}$ [mm/(N/mm <sup>2</sup> )]	0,07	0,09	0,11	0,13	0,15
Uncracked concrete temperature range III: 72°C / 120°C						
Displacement	$\delta_{N0}$ [mm/(N/mm <sup>2</sup> )]	0,06	0,08	0,10	0,13	0,14
	$\delta_{N\infty}$ [mm/(N/mm <sup>2</sup> )]	0,07	0,09	0,11	0,14	0,15
Cracked concrete temperature range I: 24°C / 40°C						
Displacement	$\delta_{N0}$ [mm/(N/mm <sup>2</sup> )]	0,11				
	$\delta_{N\infty}$ [mm/(N/mm <sup>2</sup> )]	0,16				
Cracked concrete temperature range II: 50°C / 80°C						
Displacement	$\delta_{N0}$ [mm/(N/mm <sup>2</sup> )]	0,15				
	$\delta_{N\infty}$ [mm/(N/mm <sup>2</sup> )]	0,22				
Cracked concrete temperature range III: 72°C / 120°C						
Displacement	$\delta_{N0}$ [mm/(N/mm <sup>2</sup> )]	0,20				
	$\delta_{N\infty}$ [mm/(N/mm <sup>2</sup> )]	0,29				

**Table C12: Displacements under shear load**

HIS-(R)N		M8	M10	M12	M16	M20
Displacement	$\delta_{V0}$ [mm/kN]	0,06	0,06	0,05	0,04	0,04
	$\delta_{V\infty}$ [mm/kN]	0,09	0,08	0,08	0,06	0,06

**Injection System Hilti HIT-HY 200-A V3 and HIT-HY 200-R V3**

**Performances**  
Displacements with HIS-(R)N

**Annex C17**

**Table C13: Displacements under tension load**

Hilti tension anchor HZA, HZA-R			M12	M16	M20	M24	M27
Uncracked concrete temperature range I: 24°C / 40°C							
Displacement	$\delta_{N0}$	[mm/(N/mm <sup>2</sup> )]	0,03	0,04	0,06	0,07	0,08
	$\delta_{N\infty}$	[mm/(N/mm <sup>2</sup> )]	0,06	0,08	0,13	0,13	0,15
Uncracked concrete temperature range II: 50°C / 80°C							
Displacement	$\delta_{N0}$	[mm/(N/mm <sup>2</sup> )]	0,05	0,06	0,08	0,10	0,11
	$\delta_{N\infty}$	[mm/(N/mm <sup>2</sup> )]	0,06	0,09	0,14	0,14	0,15
Uncracked concrete temperature range III: 72°C / 120°C							
Displacement	$\delta_{N0}$	[mm/(N/mm <sup>2</sup> )]	0,06	0,08	0,10	0,12	0,14
	$\delta_{N\infty}$	[mm/(N/mm <sup>2</sup> )]	0,07	0,09	0,14	0,14	0,16
Cracked concrete temperature range I: 24°C / 40°C							
Displacement	$\delta_{N0}$	[mm/(N/mm <sup>2</sup> )]	0,11				
	$\delta_{N\infty}$	[mm/(N/mm <sup>2</sup> )]	0,16				
Cracked concrete temperature range II: 50°C / 80°C							
Displacement	$\delta_{N0}$	[mm/(N/mm <sup>2</sup> )]	0,15				
	$\delta_{N\infty}$	[mm/(N/mm <sup>2</sup> )]	0,22				
Cracked concrete temperature range III: 72°C / 120°C							
Displacement	$\delta_{N0}$	[mm/(N/mm <sup>2</sup> )]	0,20				
	$\delta_{N\infty}$	[mm/(N/mm <sup>2</sup> )]	0,29				

**Table C14: Displacements under shear load**

Hilti tension anchor HZA, HZA-R			M12	M16	M20	M24	M27
Displacement	$\delta_{V0}$	[mm/kN]	0,05	0,04	0,04	0,03	0,03
	$\delta_{V\infty}$	[mm/kN]	0,08	0,06	0,06	0,05	0,05

**Injection System Hilti HIT-HY 200-A V3 and HIT-HY 200-R V3**

**Performances**  
Displacements with HZA and HZA-R

**Annex C18**

**Table C15: Displacements under tension load**

Rebar		φ 8	φ 10	φ 12	φ 14	φ 16	φ 20	φ 25	φ 26	φ 28	φ 30	φ 32
Uncracked concrete temperature range I: 24°C / 40°C												
Displacement	$\delta_{N0}$ [mm/(N/mm <sup>2</sup> )]	0,02	0,03	0,03	0,04	0,04	0,06	0,07	0,08	0,08	0,09	0,09
	$\delta_{N\infty}$ [mm/(N/mm <sup>2</sup> )]	0,04	0,05	0,06	0,07	0,08	0,10	0,13	0,14	0,15	0,16	0,17
Uncracked concrete temperature range II: 50°C / 80°C												
Displacement	$\delta_{N0}$ [mm/(N/mm <sup>2</sup> )]	0,03	0,04	0,05	0,05	0,06	0,08	0,10	0,11	0,11	0,12	0,12
	$\delta_{N\infty}$ [mm/(N/mm <sup>2</sup> )]	0,04	0,05	0,06	0,07	0,09	0,11	0,14	0,15	0,15	0,16	0,17
Uncracked concrete temperature range III: 72°C / 120°C												
Displacement	$\delta_{N0}$ [mm/(N/mm <sup>2</sup> )]	0,04	0,05	0,06	0,07	0,08	0,10	0,12	0,13	0,14	0,15	0,16
	$\delta_{N\infty}$ [mm/(N/mm <sup>2</sup> )]	0,04	0,05	0,07	0,08	0,09	0,11	0,14	0,15	0,16	0,17	0,18
Cracked concrete temperature range I: 24°C / 40°C												
Displacement	$\delta_{N0}$ [mm/(N/mm <sup>2</sup> )]	0,11										
	$\delta_{N\infty}$ [mm/(N/mm <sup>2</sup> )]	0,16										
Cracked concrete temperature range II: 50°C / 80°C												
Displacement	$\delta_{N0}$ [mm/(N/mm <sup>2</sup> )]	0,15										
	$\delta_{N\infty}$ [mm/(N/mm <sup>2</sup> )]	0,22										
Cracked concrete temperature range III: 72°C / 120°C												
Displacement	$\delta_{N0}$ [mm/(N/mm <sup>2</sup> )]	0,20										
	$\delta_{N\infty}$ [mm/(N/mm <sup>2</sup> )]	0,29										

**Table C16: Displacements under shear load**

Rebar		φ 8	φ 10	φ 12	φ 14	φ 16	φ 20	φ 25	φ 26	φ 28	φ 30	φ 32
Displacement	$\delta_{V0}$ [mm/kN]	0,06	0,05	0,05	0,04	0,04	0,04	0,03	0,03	0,03	0,03	0,03
	$\delta_{V\infty}$ [mm/kN]	0,09	0,08	0,07	0,06	0,06	0,05	0,05	0,05	0,04	0,04	0,04

**Injection System Hilti HIT-HY 200-A V3 and HIT-HY 200-R V3**

**Performances**  
Displacements with rebar

**Annex C19**

**Table C17: Essential characteristics for threaded rods according to Annex A under tension load for seismic performance category C1**

Threaded rods according to Annex A			M10	M12	M16	M20	M24	M27	M30
<b>For a working life of 50 and 100 years</b>									
<b>Steel failure</b>									
Characteristic resistance	$N_{Rk,s,C1}$	[kN]	$A_s \cdot f_{uk}$						
<b>Combined pullout and concrete cone failure for a working life of 50 years</b>									
Characteristic bond resistance in cracked concrete C20/25									
Temperature range I:	24°C/40°C	$\tau_{Rk,C1}$	[N/mm <sup>2</sup> ]	5,2	7,0				
Temperature range II:	50°C/80°C	$\tau_{Rk,C1}$	[N/mm <sup>2</sup> ]	3,9	5,7				
Temperature range III:	72°C/120°C	$\tau_{Rk,C1}$	[N/mm <sup>2</sup> ]	3,5	4,8				
<b>Combined pullout and concrete cone failure for a working life of 100 years</b>									
Characteristic bond resistance in cracked concrete C20/25									
Temperature range I:	24°C/40°C	$\tau_{Rk,100,C1}$	[N/mm <sup>2</sup> ]	4,5	6,3				
Temperature range II:	50°C/80°C	$\tau_{Rk,100,C1}$	[N/mm <sup>2</sup> ]	3,7	5,2				
Temperature range III:	72°C/120°C	$\tau_{Rk,100,C1}$	[N/mm <sup>2</sup> ]	3,1	4,4				
<b>Influence factors <math>\psi</math> on bond resistance <math>\tau_{Rk,C1}</math> and <math>\tau_{Rk,100,C1}</math> in cracked concrete</b>									
Influence of concrete strength class: $\tau_{Rk} = \tau_{Rk,(C20/25)} \cdot \psi_c$									
Temperature range I to III :	$\psi_c$	[-]	1,0						

**Table C18: Essential characteristics for threaded rods according to Annex A under shear load for seismic performance category C1**

Threaded rods according to Annex A			M10	M12	M16	M20	M24	M27	M30
<b>For a working life of 50 and 100 years</b>									
Annular gap factor without Hilti filling set	$\alpha_{gap}$	[-]	0,5						
Annular gap factor with Hilti filling set	$\alpha_{gap}$	[-]	1,0						1)
<b>Steel failure without lever arm</b>									
Characteristic resistance HAS 5.8, HAS-U 5.8, HIT-V 5.8	$V_{Rk,s,C1}$	[kN]	0,60 · $A_s \cdot f_{uk}$						
Characteristic resistance HAS 8.8, HAS-U 8.8, HIT-V 8.8, AM 8.8	$V_{Rk,s,C1}$	[kN]	0,50 · $A_s \cdot f_{uk}$						
Characteristic resistance HAS A4, HAS-U A4, HIT-V-R HAS-U HCR, HIT-V-HCR	$V_{Rk,s,C1}$	[kN]	0,50 · $A_s \cdot f_{uk}$						
Characteristic resistance Commercial standard threaded rod	$V_{Rk,s,C1}$	[kN]	0,35 · $A_s \cdot f_{uk}$						

1) No performance assessed.

**Injection System Hilti HIT-HY 200-A V3 and HIT-HY 200-R V3**

**Performances**

Essential characteristics under tension and shear load  
for seismic performance category C1

**Annex C20**

**Table C19: Essential characteristics for Hilti tension anchor HZA, HZA-R under tension load for seismic performance category C1**

Hilti tension anchor HZA, HZA-R			M12	M16	M20	M24	M27
<b>For a working life of 50 and 100 years</b>							
<b>Steel failure</b>							
Characteristic resistance HZA	$N_{Rk,s,C1}$	[kN]	46	86	135	194	253
Characteristic resistance HZA-R	$N_{Rk,s,C1}$	[kN]	62	111	173	248	<sup>1)</sup>
Partial factor	$\gamma_{Ms,N,C1}$	<sup>2)</sup> [-]	1,4				
<b>Combined pull-out and concrete cone failure</b>							
Diameter of rebar	d	[mm]	12	16	20	25	28
Characteristic bond resistance in cracked concrete C20/25							
Temperature range I:	24°C/40°C	$\tau_{Rk,C1} = \tau_{Rk,100,C1}$ [N/mm <sup>2</sup> ]	6,1				
Temperature range II:	50°C/80°C	$\tau_{Rk,C1} = \tau_{Rk,100,C1}$ [N/mm <sup>2</sup> ]	4,8				
Temperature range III:	72°C/120°C	$\tau_{Rk,C1} = \tau_{Rk,100,C1}$ [N/mm <sup>2</sup> ]	4,4				
<b>Influence factors <math>\psi</math> on bond resistance <math>\tau_{Rk,C1}</math> and <math>\tau_{Rk,100,C1}</math> in cracked concrete</b>							
Influence of concrete strength class: $\tau_{Rk} = \tau_{Rk,(C20/25)} \cdot \psi_c$							
Temperature range I to III :	$\psi_c$	[-]	1,0				

<sup>1)</sup> No performance assessed.

<sup>2)</sup> In absence of national regulations.

**Table C20: Essential characteristics for Hilti tension anchor HZA, HZA-R under shear load for seismic performance category C1**

Hilti tension anchor HZA, HZA-R			M12	M16	M20	M24	M27
<b>For a working life of 50 and 100 years</b>							
Annular gap factor without Hilti filling set	$\alpha_{gap}$	[-]	0,5				
Annular gap factor with Hilti filling set	$\alpha_{gap}$	[-]	1,0				
<b>Steel failure without lever arm</b>							
Characteristic resistance HZA	$V_{Rk,s,C1}$	[kN]	16	30	47	68	88
Characteristic resistance HZA-R	$V_{Rk,s,C1}$	[kN]	22	39	60	124	<sup>1)</sup>
Partial factor	$\gamma_{Ms,V,C1}$	<sup>2)</sup> [-]	1,5				

<sup>1)</sup> No performance assessed.

<sup>2)</sup> In absence of national regulations.

**Injection System Hilti HIT-HY 200-A V3 and HIT-HY 200-R V3**

**Performances**

Essential characteristics under tension and shear load for seismic performance category C1

**Annex C21**

**Table C21: Essential characteristics for rebar under tension load for seismic performance category C1**

Rebar		φ 10	φ 12	φ 14	φ 16	φ 20	φ 25	φ 26	φ 28	φ 30	φ 32	
<b>For a working life of 50 and 100 years</b>												
<b>Steel failure</b>												
Characteristic resistance	$N_{Rk,s,C1}$	[kN]	$A_s \cdot f_{uk}^{1)}$									
Characteristic resistance for rebar B500B acc. to DIN 488-1	$N_{Rk,s,C1}$	[kN]	43	62	85	111	173	270	292	339	388	442
<b>Combined pull-out and concrete cone failure</b>												
Diameter of rebar	$d$	[mm]	10	12	14	16	20	25	26	28	30	32
<b>Characteristic bond resistance in cracked concrete C20/25</b>												
Temperature range I: 24°C/40°C	$\tau_{Rk,C1} = \tau_{Rk,100,C1}$	[N/mm <sup>2</sup> ]	4,4	6,1								
Temperature range II: 50°C/80°C	$\tau_{Rk,C1} = \tau_{Rk,100,C1}$	[N/mm <sup>2</sup> ]	3,5	4,8								
Temperature range III: 72°C/120°C	$\tau_{Rk,C1} = \tau_{Rk,100,C1}$	[N/mm <sup>2</sup> ]	3	4,4								
<b>Influence factors <math>\psi</math> on bond resistance <math>\tau_{Rk,C1}</math> and <math>\tau_{Rk,100,C1}</math> in cracked concrete</b>												
Influence of concrete strength class: $\tau_{Rk} = \tau_{Rk,(C20/25)} \cdot \psi_c$												
Temperature range I to III :	$\psi_c$	[-]	1,0									

<sup>1)</sup>  $f_{uk}$  according to rebar specification

**Table C22: Essential characteristics for rebar under shear loads for seismic performance category C1**

Rebar		φ 10	φ 12	φ 14	φ 16	φ 20	φ 25	φ 26	φ 28	φ 30	φ 32	
<b>For a working life of 50 and 100 years</b>												
Annular gap factor without Hilti filling set	$\alpha_{gap}$	[-]	0,5									
<b>Steel failure without lever arm</b>												
Characteristic resistance	$V_{Rk,s,C1}$	[kN]	$0,35 \cdot A_s \cdot f_{uk}^{1)}$									
Characteristic resistance for rebar B500B acc. to DIN 488-1	$V_{Rk,s,C1}$	[kN]	15	22	29	39	60	95	102	118	135	155

<sup>1)</sup>  $f_{uk}$  according to rebar specification

**Injection System Hilti HIT-HY 200-A V3 and HIT-HY 200-R V3**

**Performances**

Essential characteristics under tension and shear load for seismic performance category C1

**Annex C22**

**Table C23: Essential characteristics for threaded rods according to Annex A under tension load for seismic performance category C2**

Threaded rods according to Annex A	M12	M16	M20	M24	
<b>For a working life of 50 and 100 years</b>					
<b>Steel failure</b>					
Characteristic resistance HAS (8.8, 8.8 HDG, A4), HAS-U (-8.8, -8.8 HDG, A4, HCR), HIT-V (-8.8, -8.8 F, -,R, HCR), AM (8.8, 8.8 HDG) Threaded rod (electroplated zinc coated 8.8, CRC II, CRC III and CRC V, see Table A1)	$N_{Rk,s,C2}$ [kN]		$A_s \cdot f_{uk}$		
<b>Combined pullout and concrete cone failure</b>					
Characteristic bond resistance in cracked concrete C20/25 in hammer drilled holes and hammer drilled holes with Hilti hollow drill bit TE-CD or TE-YD					
Temperature range I: 24°C/40°C	$\tau_{Rk,C2} = \tau_{Rk,100,C2}$ [N/mm <sup>2</sup> ]	2,7	4,6	4,6	3,5
Temperature range II: 50°C/80°C	$\tau_{Rk,C2} = \tau_{Rk,100,C2}$ [N/mm <sup>2</sup> ]	2,3	3,9	3,9	2,9
Temperature range III: 72°C/120°C	$\tau_{Rk,C2} = \tau_{Rk,100,C2}$ [N/mm <sup>2</sup> ]	2,0	3,3	3,3	2,5
<b>Influence factors <math>\psi</math> on bond resistance <math>\tau_{Rk,C2}</math> and <math>\tau_{Rk,100,C2}</math> in cracked concrete</b>					
Influence of concrete strength class: $\tau_{Rk} = \tau_{Rk,(C20/25)} \cdot \psi_c$					
Temperature range I to III :	$\psi_c$	[-]		1,0	

**Table C24: Essential characteristics for threaded rods according to Annex A under shear load for seismic performance category C2**

Threaded rods according to Annex A	M12	M16	M20	M24		
<b>For a working life of 50 and 100 years</b>						
Annular gap factor without Hilti filling set	$\alpha_{gap}$		[-]		0,5	
Annular gap factor with Hilti filling set	$\alpha_{gap}$		[-]		1,0	
<b>Steel failure without lever arm with Hilti Filling Set</b>						
Characteristic resistance						
HAS 8.8, HAS-U 8.8, HIT-V 8.8, AM 8.8	$V_{Rk,s,C2}$ [kN]		28	46	77	103
<b>Steel failure without lever arm without Hilti Filling Set</b>						
Characteristic resistance						
HAS 8.8, HAS-U 8.8, HIT-V 8.8, AM 8.8	$V_{Rk,s,C2}$ [kN]		24	40	71	90
HAS A4, HAS-U A4, HIT-V-R	$V_{Rk,s,C2}$ [kN]		21	35	62	79
HAS-U-HCR, HIT-V-HCR	$V_{Rk,s,C2}$ [kN]		24	40	71	79
HAS 8.8 HDG, HAS-U 8.8 HDG, HIT-V-F 8.8, AM-HDG 8.8	$V_{Rk,s,C2}$ [kN]		18	30	46	66
Threaded rod, electroplated zinc coated 8.8	$V_{Rk,s,C2}$ [kN]		17	28	50	63
Threaded rod CRC II and CRC III (Table A1)	$V_{Rk,s,C2}$ [kN]		15	25	43	55
Threaded rod CRC V (Table A1)	$V_{Rk,s,C2}$ [kN]		17	28	50	55

**Injection System Hilti HIT-HY 200-A V3 and HIT-HY 200-R V3**

**Performances**

Essential characteristics under tension and shear load  
for seismic performance category C2

**Annex C23**

**Table C25: Displacements under tension load for seismic performance category C2**

Threaded rods according to Annex A	M12	M16	M20	M24	
Displacement DLS, HAS (8.8, 8.8 HDG, A4), HAS-U (-8.8, -8.8 HDG, A4, HCR), HIT-V (-8.8, -8.8 F, -R, HCR), AM (8.8, 8.8 HDG), Threaded rod (electroplated zinc coated 8.8, CRC II, CRC III and CRC V, see Table A1)	$\delta_{N,C2(DLS)}$ [mm]	0,3	0,4	0,5	0,4
Displacement ULS, HAS (8.8, 8.8 HDG, A4), HAS-U (-8.8, -8.8 HDG, A4, HCR), HIT-V (-8.8, -8.8 F, -R, HCR), AM (8.8, 8.8 HDG), Threaded rod (electroplated zinc coated 8.8, CRC II, CRC III and CRC V, see Table A1)	$\delta_{N,C2(ULS)}$ [mm]	1,2	1,1	0,7	0,9

**Table C26: Displacements under shear load for seismic performance category C2**

Threaded rods according to Annex A	M12	M16	M20	M24	
<b>Installation with Hilti Filling Set</b>					
Displacement DLS, HAS 8.8, HAS-U 8.8, HIT-V 8.8, AM 8.8	$\delta_{V,C2(DLS)}$ [mm]	0,6	1,2	1,4	1,1
Displacement ULS, HAS 8.8, HAS-U 8.8, HIT-V 8.8, AM 8.8	$\delta_{V,C2(ULS)}$ [mm]	3,1	3,2	3,8	2,6
<b>Installation without Hilti Filling Set</b>					
Displacement DLS, HAS (8.8, A4), HAS-U (-8.8, A4, HCR), HIT-V (-8.8, -R, HCR), AM 8.8, Threaded rod (electroplated zinc coated 8.8, CRC II, CRC III and CRC V, see Table A1)	$\delta_{V,C2(DLS)}$ [mm]	1,9	3,2	2,5	3,5
Displacement DLS, HAS 8.8 HDG, HAS-U 8.8 HDG, HIT-V-F 8.8, AM HDG 8.8	$\delta_{V,C2(DLS)}$ [mm]	2,2	2,3	3,8	3,7
Displacement ULS, HAS (-8.8, A4), HAS-U (-8.8, A4, HCR), HIT-V (-8.8, -R, HCR), AM 8.8, Threaded rod (electroplated zinc coated 8.8, CRC II, CRC III and CRC V, see Table A1)	$\delta_{V,C2(ULS)}$ [mm]	4,4	9,2	7,1	10,2
Displacement ULS, HAS 8.8 HDG, HAS-U 8.8 HDG, HIT-V-F 8.8, AM HDG 8.8	$\delta_{V,C2(ULS)}$ [mm]	4,1	4,3	9,1	8,4

**Injection System Hilti HIT-HY 200-A V3 and HIT-HY 200-R V3**

**Performances**

Displacements under tension and shear load  
for seismic performance category C2

**Annex C24**

## Characteristic resistance to combined pull-out and concrete failure under fire for concrete strength classes C20/25 to C50/60 for threaded rods for all drilling methods

The characteristic bond resistance  $\tau_{Rk,fi}(\theta)$  under fire shall be calculated by using the following equations:

$$\tau_{Rk,fi}(\theta) = k_{fi,p}(\theta) \cdot \tau_{Rk,cr,C20/25}$$

$$\tau_{Rk,fi}(\theta) = k_{fi,p}(\theta) \cdot \tau_{Rk,cr,100,C20/25}$$

with:  $\theta \leq 268 \text{ °C}$ :  $k_{fi,p}(\theta) = 0,8573 \cdot e^{(-0,013 \cdot \theta)} \leq 1,0$

and  $\theta > \theta_{max}$ :  $k_{fi,p}(\theta) = 0,0$

$$\theta_{max} = 268 \text{ °C}$$

- $\tau_{Rk,fi}(\theta)$  = characteristic bond resistance for cracked concrete under fire exposure for a given temperature
- $k_{fi,p}(\theta)$  = reduction factor for bond resistance under fire conditions
- $\tau_{Rk,cr,C20/25}$  = characteristic bond resistance for cracked concrete C20/25 for a working life of 50 years given in Table C1
- $\tau_{Rk,cr,100,C20/25}$  = characteristic bond resistance for cracked concrete C20/25 for a working life of 100 years given in Table C1

**Figure C1 Reduction factor  $k_{fi,p}(\theta)$**

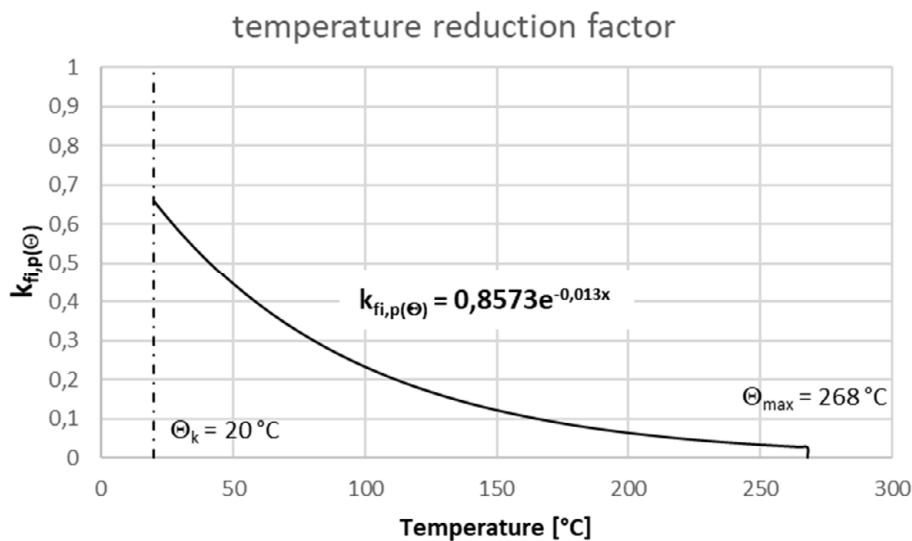

**Injection System Hilti HIT-HY 200-A V3 and HIT-HY 200-R V3**

**Performances**  
Characteristic bond resistance under fire conditions

**Annex C25**

**Table C27: Characteristic resistance to steel failure under tension loading for threaded rods in case of fire**

Threaded rods according to Annex A		M8	M10	M12	M16	M20	M24	M27	M30
HAS 5.8, HAS-U 5.8, HIT-V 5.8, AM 8.8	$N_{Rk,s,fi(30)}$	1,04	1,80	2,80	5,22	8,15	11,74	15,27	18,67
HAS 5.8 HDG, HAS-U 5.8 HDG, HIT-V-F 5.8, AM-HDG 5.8	$N_{Rk,s,fi(60)}$	0,81	1,36	2,05	3,83	5,98	8,62	11,21	13,70
HAS 8.8, HAS-U 8.8, HIT-V 8.8, AM 8.8	$N_{Rk,s,fi(90)}$	0,58	0,91	1,31	2,44	3,81	5,49	7,14	8,73
HAS 8.8 HDG, HAS-U 8.8 HDG, HIT-V-F 8.8, AM-HDG 8.8	$N_{Rk,s,fi(120)}$	0,47	0,69	0,93	1,74	2,72	3,92	5,10	6,24
HAS A4, HAS-U A4, HIT-V-R HAS-U-HCR, HIT-V-HCR Threaded rod CRC III and Threaded rod CRC V (Table A1)	$N_{Rk,s,fi(30)}$	2,70	4,93	7,93	14,77	23,06	33,23	43,20	52,81
	$N_{Rk,s,fi(60)}$	1,93	3,49	5,56	10,37	16,18	23,31	30,31	37,05
	$N_{Rk,s,fi(90)}$	1,17	2,04	3,20	5,96	9,30	13,40	17,42	21,29
	$N_{Rk,s,fi(120)}$	0,79	1,32	2,01	3,75	5,86	8,44	10,98	13,42

**Table C28: Characteristic resistance under tension load for concrete cone failure in case of fire**

Threaded rods according to Annex A		M8	M10	M12	M16	M20	M24	M27	M30
HAS 5.8, HAS-U 5.8, HIT-V 5.8, AM 8.8	$N_{Rk,c,fi(30)}$	$h_{ef}/200 \cdot N_{Rk,c}^0 \leq N_{Rk,c}^0$							
HAS 5.8 HDG, HAS-U 5.8 HDG, HIT-V-F 5.8, AM-HDG 5.8	$N_{Rk,c,fi(60)}$								
HAS 8.8, HAS-U 8.8, HIT-V 8.8, AM 8.8	$N_{Rk,c,fi(90)}$								
HAS 8.8 HDG, HAS-U 8.8 HDG, HIT-V-F 8.8, AM-HDG 8.8	$N_{Rk,c,fi(120)}$								
Characteristic spacing	$S_{cr,N,fi}$	$4 \cdot h_{ef}$							
Characteristic edge distance	$C_{cr,N,fi}$	$2 \cdot h_{ef}$							

**Injection System Hilti HIT-HY 200-A V3 and HIT-HY 200-R V3**

**Performances**

Fire resistance to steel and concrete cone failure under tension loading

**Annex C26**

**Table C29: Characteristic resistance to steel failure under shear loading without lever arm for threaded rods in case of fire**

Threaded rods according to Annex A		M8	M10	M12	M16	M20	M24	M27	M30
HAS 5.8, HAS-U 5.8, HIT-V 5.8, AM 8.8	$V_{Rk,s,fi(30)}$	1,04	1,80	2,80	5,22	8,15	11,74	15,27	18,67
HAS 5.8 HDG, HAS-U 5.8 HDG, HIT-V-F 5.8, AM-HDG 5.8	$V_{Rk,s,fi(60)}$	0,81	1,36	2,05	3,83	5,98	8,62	11,21	13,70
HAS 8.8, HAS-U 8.8, HIT-V 8.8, AM 8.8	$V_{Rk,s,fi(30)}$	0,58	0,91	1,31	2,44	3,81	5,49	7,14	8,73
HAS 8.8 HDG, HAS-U 8.8 HDG, HIT-V-F 8.8, AM-HDG 8.8	$V_{Rk,s,fi(120)}$	0,47	0,69	0,93	1,74	2,72	3,92	5,10	6,24
HAS A4, HAS-U A4, HIT-V-R HAS-U-HCR, HIT-V-HCR Threaded rod CRC III and Threaded rod CRC V (Table A1)	$V_{Rk,s,fi(30)}$	2,70	4,93	7,93	14,77	23,06	33,23	43,20	52,81
	$V_{Rk,s,fi(30)}$	1,93	3,49	5,56	10,37	16,18	23,31	30,31	37,05
	$V_{Rk,s,fi(30)}$	1,17	2,04	3,20	5,96	9,30	13,40	17,42	21,29
	$V_{Rk,s,fi(120)}$	0,79	1,32	2,01	3,75	5,86	8,44	10,98	13,42

**Table C30: Characteristic resistance to steel failure under shear loading with lever arm for threaded rods in case of fire**

Threaded rods according to Annex A		M8	M10	M12	M16	M20	M24	M27	M30
HAS 5.8, HAS-U 5.8, HIT-V 5.8, AM 8.8	$M^0_{Rk,s,fi(30)}$	1,07	2,33	4,36	11,08	21,60	37,36	55,40	74,85
HAS 5.8 HDG, HAS-U 5.8 HDG, HIT-V-F 5.8, AM-HDG 5.8	$M^0_{Rk,s,fi(60)}$	0,83	1,75	3,19	8,13	15,85	27,41	40,65	54,92
HAS 8.8, HAS-U 8.8, HIT-V 8.8, AM 8.8	$M^0_{Rk,s,fi(30)}$	0,60	1,18	2,03	5,18	10,10	17,46	25,90	34,99
HAS 8.8 HDG, HAS-U 8.8 HDG, HIT-V-F 8.8, AM-HDG 8.8	$M^0_{Rk,s,fi(120)}$	0,48	0,89	1,45	3,70	7,22	12,49	18,52	25,03
HAS A4, HAS-U A4, HIT-V-R HAS-U-HCR, HIT-V-HCR Threaded rod CRC III and Threaded rod CRC V (Table A1)	$M^0_{Rk,s,fi(30)}$	2,76	6,35	12,33	31,34	61,10	105,6	156,6	211,7
	$M^0_{Rk,s,fi(30)}$	1,98	4,49	8,65	21,99	42,87	74,14	109,9	148,5
	$M^0_{Rk,s,fi(30)}$	1,20	2,64	4,97	12,64	24,64	42,61	63,19	85,38
	$M^0_{Rk,s,fi(120)}$	0,80	1,71	3,13	7,96	15,52	26,85	39,81	53,80

**Injection System Hilti HIT-HY 200-A V3 and HIT-HY 200-R V3**

**Performances**  
Fire resistance to steel failure under shear loading

**Annex C27**